



**SCOTTISHPOWER
RENEWABLES**

East Anglia ONE North Offshore Windfarm

Appendix 7.2

Individual Project and Cumulative Wave Modelling

Environmental Statement Volume 3

Applicant: East Anglia ONE North Limited

Document Reference: 6.3.7.2

SPR Reference: EA1N-DWF-ENV-REP-IBR-000899_002 Rev 01

Pursuant to APFP Regulation: 5(2)(a)

Author: Royal HaskoningDHV

Date: October 2019

Revision: Version 1

Revision Summary

Rev	Date	Prepared by	Checked by	Approved by
01	08/10/2019	Paolo Pizzolla	Ian MacKay	Helen Walker

Description of Revisions

Rev	Page	Section	Description
01	n/a	n/a	Final for Submission

Table of Contents

1	Introduction	1
1.1	Purpose of this document	1
1.2	Overview	1
2	Approach to wave modelling	2
2.1	Context	2
2.2	General approach	4
2.3	Defining a suitable offshore wave climate	4
2.4	Local scale wave modelling	6
2.5	Spectral wave modelling	7
3	Defining worst case scenarios	12
3.1.1	East Anglia TWO and East Anglia ONE North projects	12
3.1.2	Cumulative assessments	13
4	Wave modelling results	18
4.1.1	Baseline	18
4.1.2	Proposed East Anglia TWO project	20
4.1.3	Proposed East Anglia ONE North project	22
4.1.4	Cumulative assessments	25
5	Conclusions	35
6	References	37
	Appendix A – Offshore wave climate	39
	Background	39
	Wave Data	
		39
	Wave Extremes Analysis	42
	Appendix B – Local scale wave modelling using DIFFRACT	45
	Background	
		45
	Introduction	
		45
	Methodology	45
	Definition of wave reflection coefficient	45
	Calculation of wave reflection coefficient	47
	Foundations and corresponding meshes	48
	Results of wave reflection coefficients	56
	Concluding remarks	60

References	61
Appendix C – Set-up and verification of MIKE21 spectral wave model	62
Background	62
Model Setup	64
Model Verification	68
Auxiliary Wave Model Runs	81
Main Wave Model Runs	82
Appendix D – Response to Discussion Comments from Cefas on Presentation of Wave Model Results	83
Background	
	83
Waves from the Southeast	83
Threshold for Wave Effects	86
Zone of Influence of Wave Effects	86
Transboundary Effects	88
Wave Regime	89
Tidal Regime	90
Sediment Regime	92
Conclusion	
	94

1 Introduction

1.1 Purpose of this document

1. This report has been produced to summarise the individual project and cumulative wave modelling which has been undertaken to support the proposed East Anglia TWO and East Anglia ONE North projects.
2. The wave modelling has been undertaken in response to comments provided by Cefas (see Cefas, 2017) on the Physical Processes Method Statement (see Scottish Power Renewables, 2017a) which was submitted by Scottish Power Renewables via the Evidence Plan Process.
3. A meeting was held on 18th October 2017 with Cefas, MMO and Natural England to discuss the comments raised in relation to the Physical Processes Method Statement and, following this, a Briefing Note on Individual Project and Cumulative Wave Modelling was produced to confirm the approach to addressing the comments (see Scottish Power Renewables, 2017b).
4. Following review of the Briefing Note, MMO confirmed in writing that both they and Cefas were satisfied with the approach to individual and cumulative wave modelling proposed in the Briefing Note (see MMO, 2017).

1.2 Overview

5. The individual and cumulative wave modelling has now been undertaken and this report presents the following:
 - Approach to wave modelling
 - Defining worst case scenarios
 - Wave modelling results
 - Conclusions
6. The report is supported by a series of technical appendices which provide further detail about the wave data used and the wave modelling which has been undertaken. Appendix A presents analysis of the offshore wave climate, with Appendix B covering the local scale wave modelling of individual wind turbine foundations. Appendix C contains details of the spectral wave modelling. In addition, Appendix D provides responses to discussion comments from Cefas on a presentation of the wave modelling results made at a meeting held on 21st March 2018 in London. Appendix D also contains an assessment of the potential for transboundary effects in the context of physical process, concluding

with a recommendation that these be scoped out from further assessment in the Environmental Statement.

2 Approach to wave modelling

2.1 Context

7. In response to the Physical Processes Method Statement submitted to the MMO and Cefas for review in April 2017, Cefas raised concerns about the potential impact of the latest round of windfarm projects on the wave climate, either individually or cumulatively with other windfarm projects. This is primarily because the proposed East Anglia TWO and East Anglia ONE North projects are significantly closer to the coast than other windfarm project developments within the former East Anglia zone (i.e. East Anglia ONE, East Anglia THREE, Norfolk Vanguard and Norfolk Boreas).
8. There are various receptors within the southern North Sea with the potential to be impacted by changes in wave climate, including sensitive coastlines and designated sites with interest features supporting sea bed habitats and features (**Figure 1**).
9. Cefas requested wave modelling to be undertaken to provide reassurance that the development of the proposed East Anglia TWO and East Anglia ONE North projects, when considered both individually and cumulatively with other windfarm developments, would not result in significant changes in the wave regime experienced by sensitive receptors.

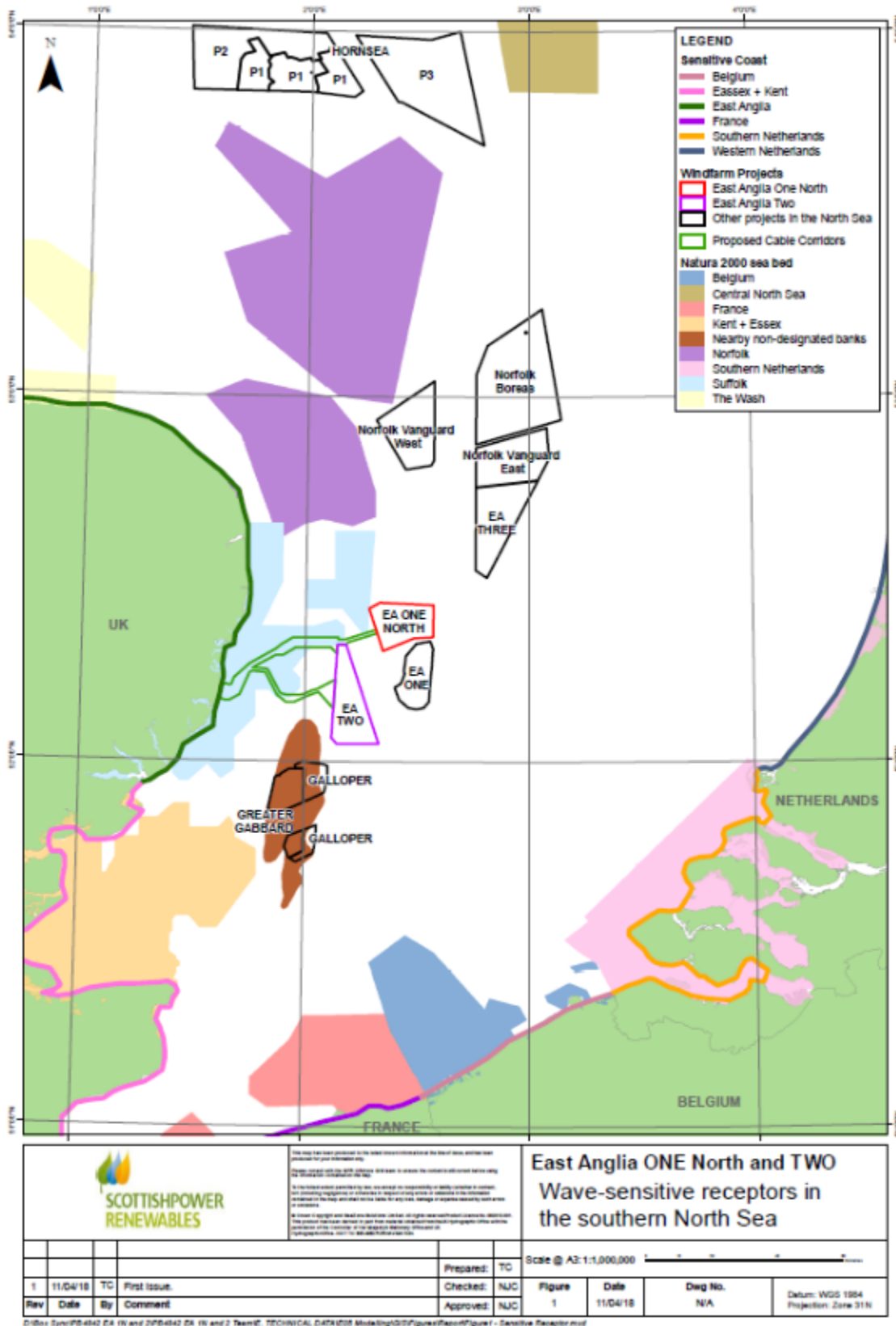

Figure 1: Wave sensitive receptors in the southern North Sea

2.2 General approach

10. The general approach to the wave modelling involves four principal stages, namely:
 - Defining a suitable offshore wave climate;
 - Local scale wave modelling to characterise wave reflection properties of different foundation types or sizes;
 - Regional scale spectral wave modelling to quantify the location and magnitude of any far-field effects on the wave climate; and
 - Interpretation and presentation of the results.
11. This approach is similar to that used for various other marine and coastal EIAs, including several offshore windfarm developments such as Horns Rev 3 (Orbicon & Royal HaskoningDHV, 2014), Dogger Bank Creyke Beck (Forewind, 2013) and Dogger Bank Teesside A & B (Forewind, 2014).

2.3 Defining a suitable offshore wave climate

12. “Re-map” wave hindcast data was acquired from the UK Met Office at a deep water (offshore) location on the boundary of the MIKE21-SW spectral wave model (**Plate 2:1**), defining model boundary conditions.

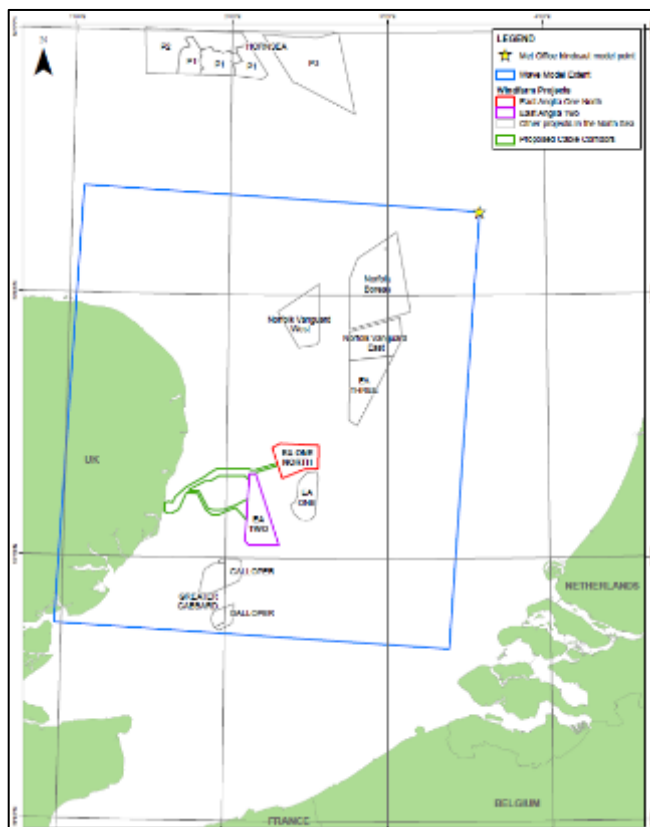

Plate 2:1: Location of Met Office hindcast model data point

- 13. The “re-map” data is a 36 year long wave hindcast dataset reproduced using the WaveWatch III model; a wave model which is currently adopted by the UK Met Office for wave forecasting in real time. Data was acquired covering the period from 01/01/1980 to 31/08/2017.
- 14. **Plate 2.2** shows the wave rose generated using the Met Office hindcast data.

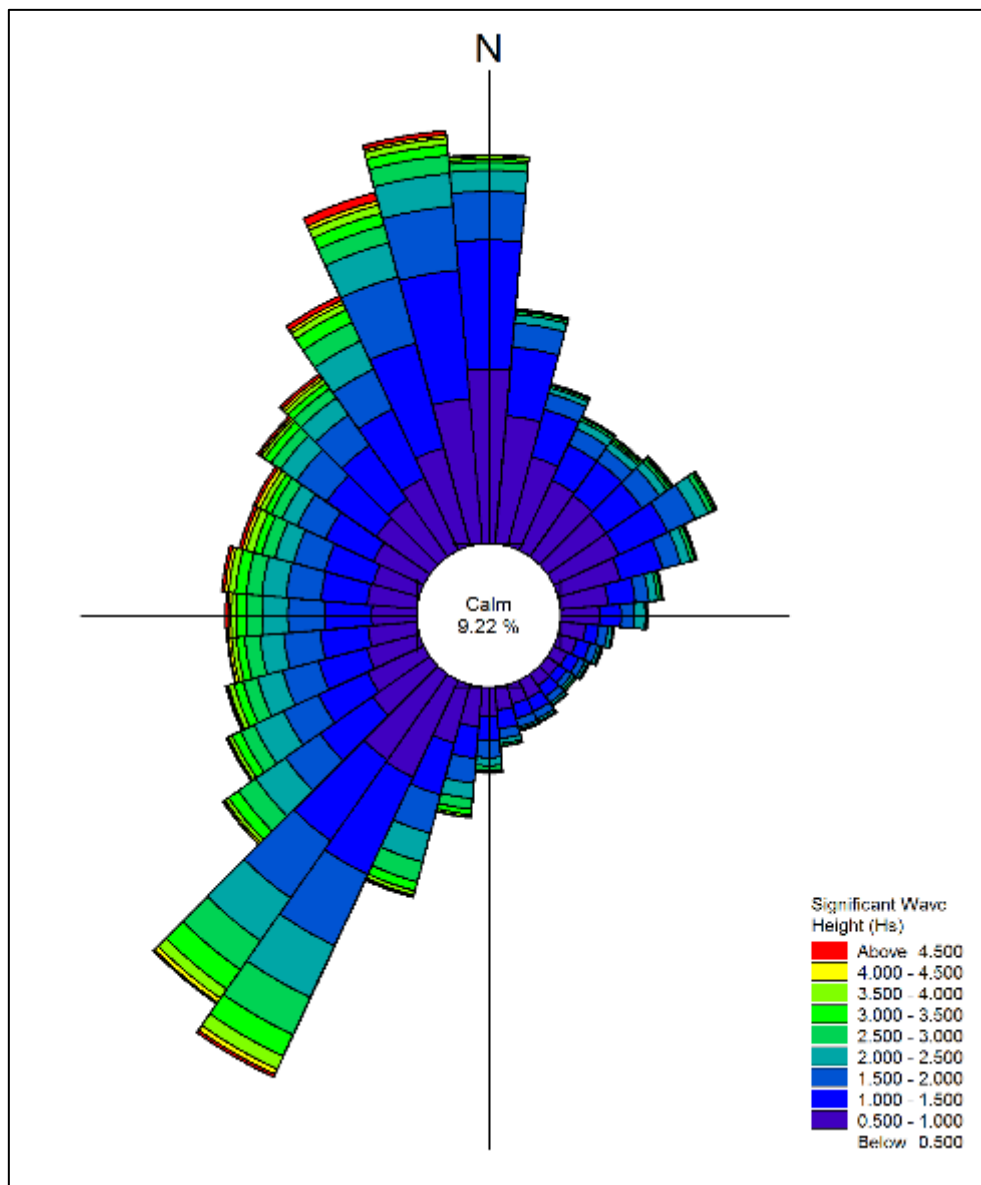

Plate 2.2: Wave rose of hindcast model data

15. The waves which have the greatest potential to cause cumulative effects between projects upon identified receptors are from the North to East sectors. Of these, waves from due north (N) are of the greatest dominance in terms of both frequency and magnitude of wave events. Waves from north-northeast (NNE) or east-northeast (ENE) are less frequent and waves from due east (E) are less frequent and lower in magnitude still.
16. In-house extreme value analysis software, EXTREME, was used to derive 1 in 1 year and 1 in 50 year significant wave height (H_s) conditions for wave impact assessment. Using the EXTREME software, statistical fits to the data were undertaken using the Gumbel, Weibull and GEV distribution methods, and a preferred method was selected that provided the best statistical fitting to the data. Waves from a range of directional approach sectors were considered. The results are presented in **Table 2.1**.

Table 1: Significant wave height (H_s) conditions for 1 in 1 year and 1 in 50 year extreme events

Wave Direction	H_s (m) for 1 in 1 year event	H_s (m) for 1 in 50 year event
North (N)	4.77	7.59
North-North-East (NNE)	3.62	5.84
East-North-East (ENE)	3.48	4.42
East (E)	3.04	4.14

17. These offshore wave conditions for specified return period events and directions were defined for subsequent use as input to the MIKE21-SW spectral wave model.
18. A full description of the approach to determining the offshore wave climate is provided in Appendix A.

2.4 Local scale wave modelling

19. In order to determine the effects of foundation types on the near-field wave climate, a local scale wave model known as DIFFRACT was used. This model allows the foundation parameters to be digitised. An example 3D representation of a gravity base structure (GBS) in DIFFRACT is shown in **Plate 2.3**. The DIFFRACT model enables the relative reflection (or transmission) properties of different foundation types to be parameterised by means of controlled tests, providing numerical 'coefficients'. The sensitivity of the resultant coefficients to wave period and water depth was analysed for each foundation type tested.

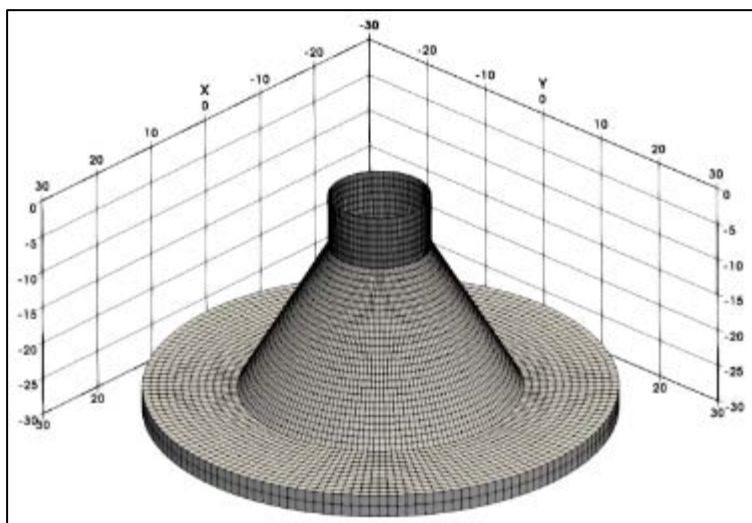

Plate 2:3: Example numerical mesh for GBS foundation in water depth of 30 m

20. A full description of the local scale wave modelling using DIFFRACT is provided in Appendix B.

2.5 Spectral wave modelling

21. A spectral wave model was set-up, verified against measured field data and run to establish the baseline far-field wave climate. Then, using the reflection coefficients output from the DIFFRACT model as the basis of representing the individual wind turbine foundations at a sub-grid scale within the spectral wave model, a series of runs were performed to:
1. Quantify the changes to the baseline from the proposed East Anglia ONE North project individually;
 2. Quantify the changes to the baseline from the proposed East Anglia TWO project individually; and
 3. Quantify the changes to the baseline caused by all ‘scoped-in’ projects cumulatively.
22. The MIKE21-SW modelling software was used for this purpose. This is an industry standard spectral wave model with comparable functionality to the SWAN Spectral Model. Table 2 shows a comparison between the function of both model types.

Table 2 Comparison of MIKE21-SW and SWAN functionality

Function	MIKE 21-SW	SWAN
Brief Description	State-of-the-art third generation spectral wind-wave model that simulates the growth, decay and transformation of wind-	State-of-the-art third generation spectral wind-wave model that simulates the random, short-crested wind-

Function	MIKE 21-SW	SWAN
	generated waves and swells in offshore and coastal areas.	generated waves in coastal areas and inland waters.
Developer	Danish Hydraulic Institute (DHI)	Delft University of Technology (DUT)
Computational Mesh	Flexible mesh	Regular or flexible mesh (curvilinear or triangular)
Wave growth by action of wind	Yes	Yes
Non-linear wave-wave interaction	Yes	Yes
Dissipation due to white-capping	Yes	Yes
Dissipation due to bottom friction	Yes	Yes
Dissipation due to depth-induced wave breaking	Yes	Yes
Refraction due to depth variations	Yes	Yes
Shoaling due to depth variations	Yes	Yes
Wave-current interaction	Yes	Yes
Wave reflection	Yes, an array of reflection / transmission coefficients can be defined for various wave heights, periods and water depths which provides a facility to take on output from the CFD model (DIFFRACT) simulation of reflection / transmission around foundations at a local scale	Yes, but it is defined by a single constant coefficient
Wave diffraction	Yes, but approximate and not well suited for structure scale diffraction (focused on diffraction due to headlands)	Yes, but approximate and not well suited for structure scale diffraction (focused on diffraction due to headlands)
Effect of time-varying water depth	Yes	Yes
Effect of ice coverage on wave field	Yes (but not relevant in this case)	No (but not relevant in this case)

Function	MIKE 21-SW	SWAN
Software status	Industry standard	Industry standard

23. The individual assessments for the proposed East Anglia TWO and East Anglia ONE North projects were performed using the main MIKE21 SW wave model. Cumulative assessments were undertaken in two stages, primarily because establishing a single MIKE21 SW wave model over an extensive area of sea bed, with fine resolution grids over all wind farm projects to be included within the cumulative assessments, would have been computationally inefficient.
24. Instead, therefore, an auxiliary model was set up to first examine the potential for interactions between the Hornsea Offshore Wind Farm projects and the area formerly known as the East Anglia Zone.
25. Following this, the main wave model was used to consider cumulative effects between the Norfolk Boreas, Norfolk Vanguard, East Anglia ONE, East Anglia ONE North, East Anglia TWO, East Anglia THREE, Greater Gabbard and Galloper wind farms.
26. The extent and bathymetry of the main wave model is shown in **Plate 2.4** and the auxiliary wave model in **Plate 2.5**.

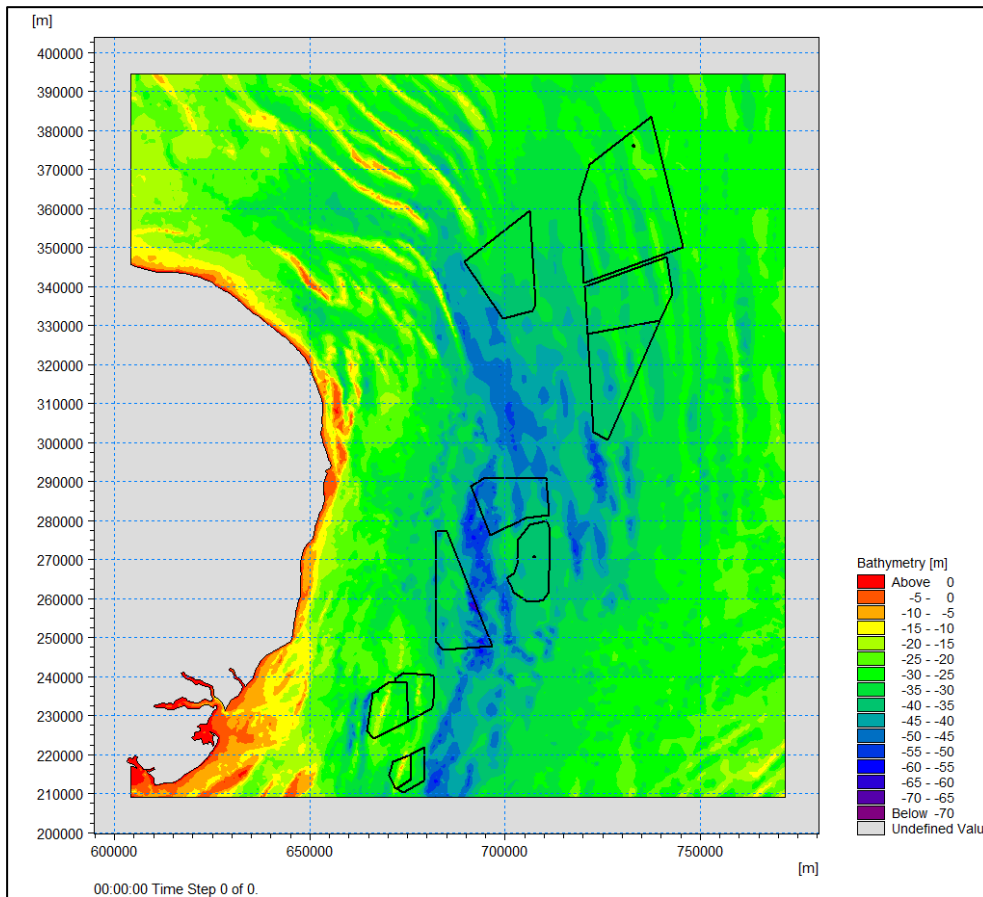

Plate 2:4: Main wave model extent and bathymetry

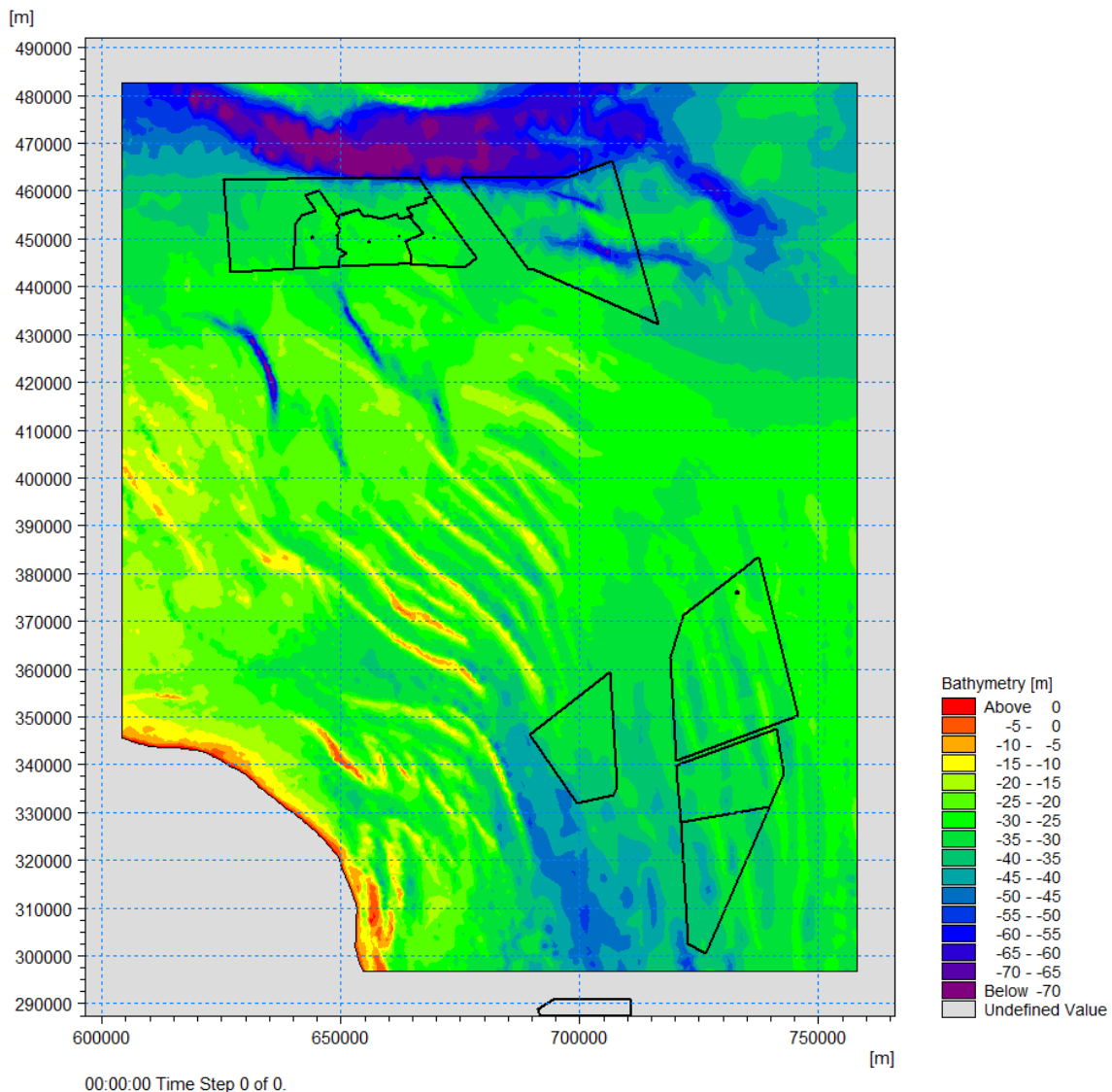

Plate 2:5: Auxiliary wave model extent and bathymetry

27. Model outputs from the ‘with scheme’ model runs (either individually or cumulatively) were compared against the model outputs from the ‘baseline’ model runs to quantify the changes in wave regime at the location of sensitive receptors (e.g. shoreline, sandbanks or conservation features sensitive to changes in the wave regime). As agreed with Cefas, specifically the individual or cumulative impacts on the wave regime at sensitive receptors should be less than 5%. This threshold is widely used in a number of sectors and is based on a pragmatic and risk-based approach to changes in the wave climate that reflects the dynamic nature of the marine environment and the inherent uncertainties in terms of both measurement and modelling accuracies.
28. A full description of the set-up and verification of the MIKE21-SW spectral wave modelling is provided in **Appendix C**.

3 Defining worst case scenarios

3.1.1 East Anglia TWO and East Anglia ONE North projects

29. At this stage of the EIA process, the Rochdale Envelope for both individual projects includes the following foundation types:
- Monopiles;
 - Gravity base structure (GBS);
 - Jackets on pin-piles or suction caissons;
 - Suction caisson.
30. Project parameters relevant to each foundation type are provided in **Table 3.1**. Generally, those foundation types which create the greatest continuous physical blockage in the water column (especially in its uppermost sections) are the ones which create the greatest potential effect on the wave climate. This means that for a given wind turbine rating, GBS and, to a lesser extent, large diameter monopiles are likely to have a greater effect on the wave regime than jackets (which due to their lattice structure of relatively slender piles is somewhat more 'open' to wave transmission) and caissons (which occupy only a short height off the sea bed).
31. For wave modelling purposes, it has been assumed that GBS represent the worst case foundation type for the proposed East Anglia ONE North and East Anglia TWO projects and that 100% of wind turbine foundations for each project will be GBS.

Table 3 Project parameters for the proposed East Anglia TWO and East Anglia ONE North projects

Parameter	East Anglia TWO	East Anglia ONE North
Maximum number of wind turbine foundations	67	62
Minimum inter-row spacing (between foundations)	1,210m	
Maximum number of met-masts	1	
Maximum number of electrical platforms	4	
Maximum number of accommodation platforms	1	
Maximum monopile diameter	15m	

Parameter	East Anglia TWO	East Anglia ONE North
Maximum jacket (length x width)	53m x 53m	
Maximum jacket pile diameter	4.6m	
Maximum jacket caisson diameter	16m	
Maximum GBS base diameter	60m	
Maximum GBS column width	13m	
Maximum suction caisson base diameter	35m	

32. At the present time, each project may have 12MW, 15MW or 19MW rated wind turbines. If the lower rated wind turbines are selected, there will be a greater number of them more closely spaced (i.e. maximum numbers and minimum spacing as defined in **Table 3.1**), but each of the wind turbine foundations will be (slightly) smaller. If the higher rated wind turbines are selected, there will be fewer of them more widely spaced, but each of the wind turbine foundations will be (slightly) larger (i.e. maximum dimensions as defined in **Table 3.1**).
33. To adopt a conservative approach to the individual project and cumulative wave modelling, and to avoid any residual uncertainty in any modelling outputs, the larger dimensions of the 19MW GBS (shown in **Plate 3.1**) have been used together with the larger number of wind turbines and closer spacings of the 12MW layout in the worst case scenario (WCS).

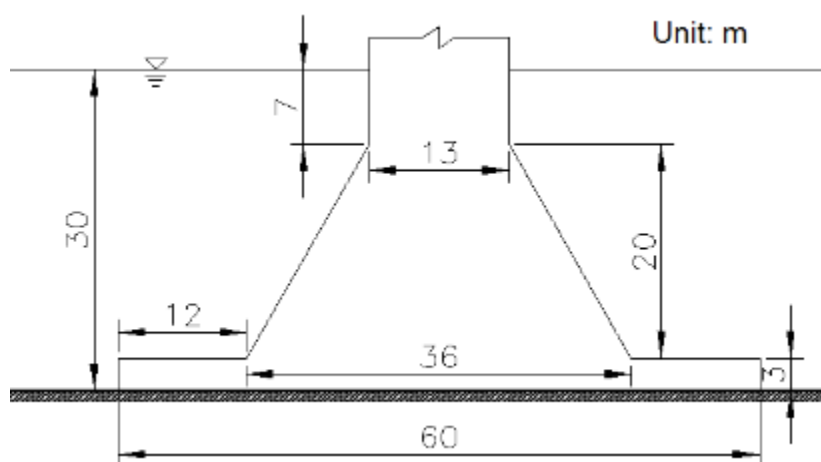

Plate 3.1: GBS dimensions for 19MW wind turbines (here shown in 30m water depth)

3.1.2 Cumulative assessments

34. The Briefing Note on Individual Project and Cumulative Wave Modelling (SPR, 2017b) presented a basis for determining which other projects should be

included within the cumulative impact assessments, including a justification of any projects which could be scoped out on the basis of:

- Geographical location (i.e. distance away from other wind farms):
- Dominant wave direction (i.e. lack of alignment with respect to other wind farms): and
- Previous assessments of effects on waves from these projects' environmental statements (where they concluded negligible cumulative effects).

35. As a result of this process, the Briefing Note identified that those projects listed in **Table 3.2** should be included within the cumulative impact assessments, with all others being scoped out. For those projects to be included, publically available information was used to determine the most appropriate worst case scenario for each windfarm development. Where these projects are currently at planning or pre-construction stage, the worst case scenario for physical processes from the project's EIA was used, whilst for projects which have already been (or are currently being) constructed the 'as built' details were considered where these are publically available otherwise the worst case scenario for physical processes from the project's EIA was used.

Table 4 WCS foundations for offshore windfarms included in cumulative assessment

Project [status]	Wind Turbine Foundation			Platform Foundation		
	No.	Type	Dimensions (water depth) [spacing]	No.	Type	Dimensions
East Anglia ONE [in construction]	102	Mono-pile [N1]	6.5m diameter	2	Mono-pile [N1]	6.5m diameter
East Anglia THREE [pre-construction]	100	GBS	60m slab diameter 9m cone top diam (24 – 48 m) [675m / 900m]	7	GBS	104m slab diameter
	72	Mono-pile	12 m diameter (24 – 48 m) [675m / 900m]			

Project [status]	Wind Turbine Foundation			Platform Foundation		
	No.	Type	Dimensions (water depth) [spacing]	No.	Type	Dimensions
Norfolk Vanguard (NV) [planning]	85 in NV West & 172 in NV East [N2] [N3]	GBS	40 m slab diameter (22 – 50 m) [616m / 6060m]	5	GBS	40m slab diameter
				2 met mast	GBS	20m diameter
Norfolk Boreas [planning]	257	GBS	50m slab diameter 9m cone top diameter (22 – 41m) [616m / 6060m]	4	GBS	40m slab diameter
Greater Gabbard [operational]	140	Mono-pile	6.3m diameter	2	Jacket	[N4]
Galloper [construction]	56	Mono-pile	7.5m diameter	1	Jacket	[N4]
Hornsea Project 1 [construction]	174	Mono-pile	8.5m diameter (24 – 37m) [924m]	6	Mono-pile	8.5m diameter
Hornsea Project 2 [pre-construction]	300	GBS	58m slab diameter 13m cone top diameter (30 – 40m) [810m]	8	GBS	50m slab diameter
Hornsea Project 3 [planning]	342	GBS	53m slab diameter 15 m cone top diameter (30 – 40m) [1000m]	19	GBS	75m slab diameter

Notes associated with **Table 3.2:**

- [N1] Although the East Anglia ONE project is being built using jackets for wind turbine and platform foundations, for purposes of modelling a 6.5m diameter monopile foundation has been assumed. This is due to the difficulty in assessing a reflection coefficient for a jacket in the DIFFRACT model due to the complex nature of the jacket structure with pin piles and horizontal and diagonal cross members. A monopile is considered more likely to exert an influence on wave climate than a jacket.
- [N2] The Norfolk Vanguard PEIR (see Royal HaskoningDHV & Vattenfall, 2017) concluded that a larger number of smaller diameter GBS foundations, being more closely spaced within the project area, represented a worse case over the smaller number of larger diameter GBS foundations at wider spacing. This was due to the large envelope of wind turbine ratings being considered (7MW to 20MW) and the associated variances in GBS dimensions and wind turbine spacing considered for that project.
- [N3] For Norfolk Vanguard (NV), there are two potential layout scenarios: (i) all 257 wind turbines could be located in NV West; or (ii) 85 wind turbines could be in NV West and 172 wind turbines in NV East. In the cumulative assessments, it is considered that the latter option presents a WCS because, based on the geographical locations of the projects within the East Anglia Zone and the predominant wave approach directions, there is greatest potential for 'between project' interactions under this scenario. The more northerly wave approach direction in the deepest offshore waters to the north of the former East Anglia Zone could potentially create interactions between Norfolk Boreas and Norfolk Vanguard East, potentially extending on to the East Anglia THREE project and then, due to the more north-easterly approach of waves in the southern sector of the former East Anglia Zone, towards the grouping of the East Anglia ONE project, the proposed East Anglia ONE North project and potentially in turn the proposed East Anglia TWO project. The potential for the effect arising from wind turbines within Norfolk Vanguard West, even if all 257 were located here, to interact with either the East Anglia THREE project or proposed East Anglia ONE North project is limited by the considerably larger distances between the projects along the axes of wave approach directions.
- [N4] For similar reasons to those described in N1, the 2 no. platform jacket foundations for Greater Gabbard and the 1 no. platform jacket foundation for Galloper were replicated in the model using monopiles of a similar size to those for the wind turbines for each project.
36. The wind turbine, platform and, where appropriate, met mast foundation types were characterised in the spectral wave model at a sub-grid scale by means of a wave reflection coefficient in a similar manner to that previously described for the individual project assessments.
37. Appropriate wave reflection coefficients were derived from a pre-existing in-house database for foundations of differing type and size in different water depths and under different wave periods. This has been established over time based on local scale modelling studies, typically using the DIFFRACT or WAMIT software. It was noticeable that wave reflection coefficients for two foundation scenarios that needed to be included in the cumulative assessments, namely

6.5m diameter monopile (**Plate 3.2**) and 12m diameter monopile, were not available from the pre-existing in-house knowledge-base. Therefore, these foundation types and sizes were specially modelled within this study to provide the necessary information (results are included within the full description of the local scale wave modelling using DIFFRACT that is provided in **Appendix B**).

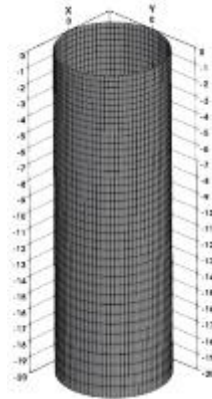

Plate 3:2: Numerical mesh for 6.5 m diameter monopile in 20 m water depth

4 Wave modelling results

4.1.1 Baseline

38. The baseline model runs are shown in **Plates 4.1 to 4.6** for both 1 in 1 year return period events and for 1 in 50 year return period events from approach directions of north (N), nor-northeast (NNE) and east (E). For a given return period event, offshore wave conditions are greatest under a northerly approach direction and least under waves from due east, as confirmed by analysis of the offshore wave climate provided in **Appendix A**.

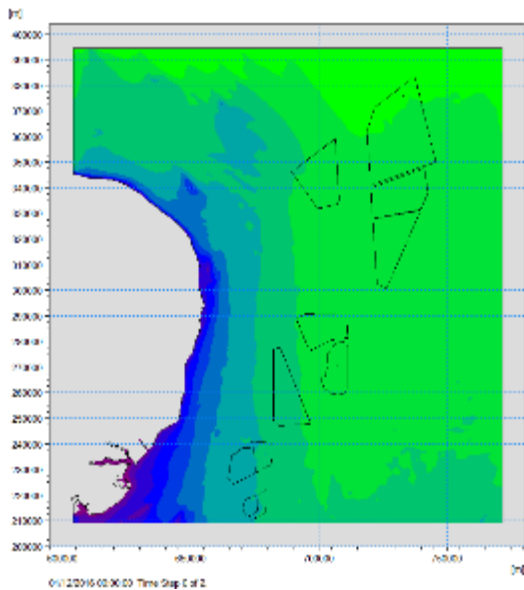

Plate 4:1: 1 in 1 year return period event (waves from N)

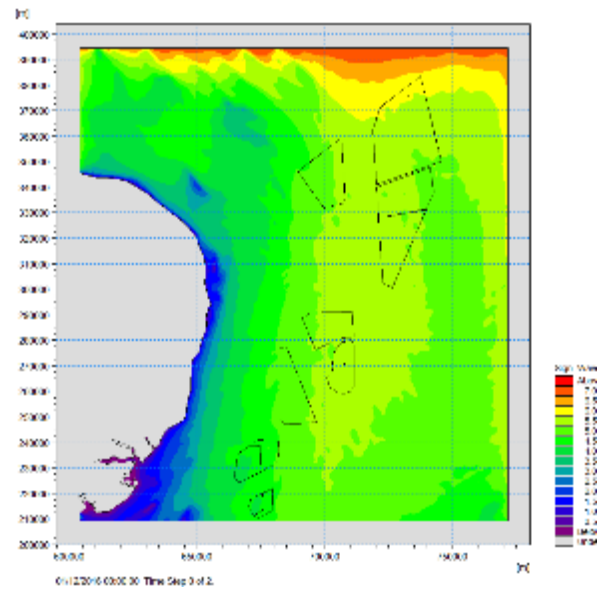
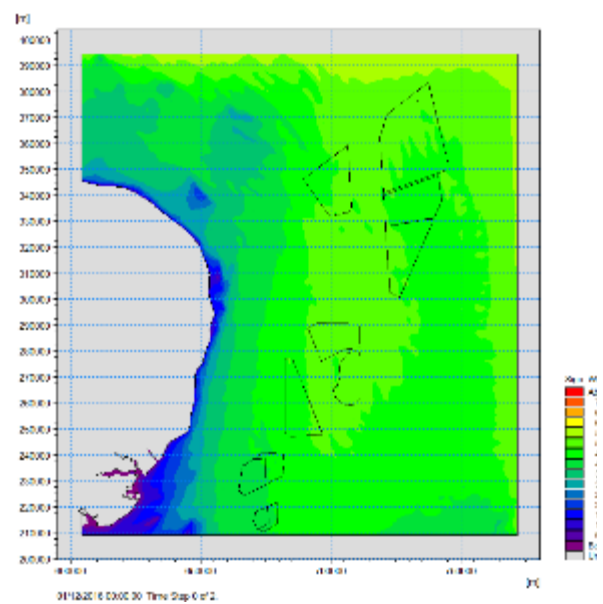
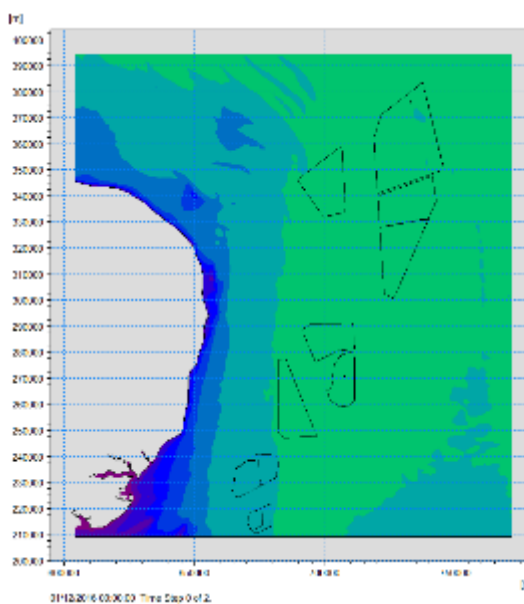
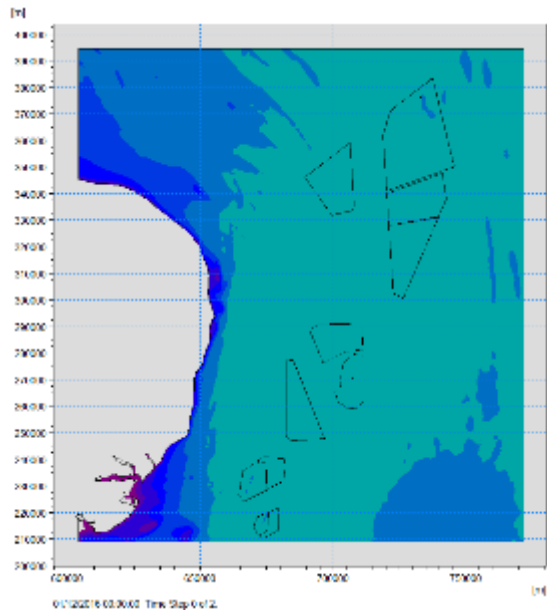

Plate 4:2: 1 in 50 year return period event (waves from N)

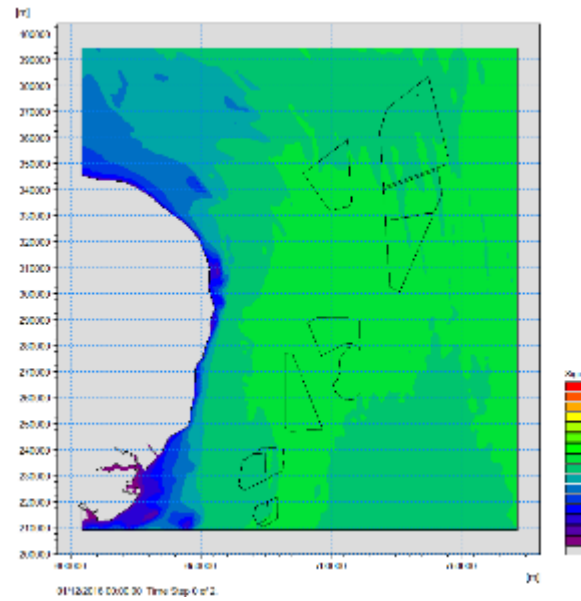

**Plate 4:3: 1 in 1 year return period event
(waves from NNE)**



**Plate 4:5: 1 in 1 year return period event
(waves from E)**

**Plate 4:4: 1 in 50 year return period event
(waves from NNE)**



**Plate 4:6: 1 in 50 year return period event
(waves from E)**

4.1.2 Proposed East Anglia TWO project

39. The individual project modelling for the proposed East Anglia TWO project comprised runs for 1 in 1 year and 1 in 50 year return period events from each of three directions, namely north, nor-northeast and east.
40. Under the northerly approach direction, a zone of effect on the baseline wave climate was created following introduction of the proposed East Anglia TWO project. This comprised both a zone of wave height increases in an 'up wave' direction, caused by reflection off the wind turbine foundations and a zone of wave sheltering in a 'down-wave' direction. Within the centre of the array these effects largely balanced out, so changes were less than $\pm 0.5\%$ of baseline wave heights and therefore have been 'blanked out' in the legend of the plates which follow.
41. The zone of effect on the baseline wave climate does not impinge on the northern-most section of the Greater Gabbard or Galloper project boundaries, and in any case the changes in baseline wave height observed were very small ($<1\%$) and therefore deemed insignificant (**Plate 4.7**). Under a 1 in 50 year event the zone of effect covered a negligible area (**Plate 4.8**) and consequently was also deemed insignificant.
42. For waves approaching from nor-northeast, the zone of effect on baseline wave climate exhibited a different alignment but still did not impinge upon the Greater Gabbard or Galloper project boundaries. Once again the observed changes were very small in magnitude ($<1\%$) and deemed insignificant (**Plate 4.9**). Similar to the results for waves from due north, under a 1 in 50 year event the change in wave height for waves approaching for nor-northeast covered an even smaller extent than for the 1 in 1 year event and changes typically were $<0.5\%$ (**Plate 4.10**). The magnitude and scale of these changes were also deemed insignificant.
43. Waves from due east (which have considerably lower incident wave heights for the given return periods than waves from due north or nor-northeast) resulted in a zone of wave sheltering effect directed towards the shore. However, the zone of effect does not reach the shore and in any case the change in baseline wave climate is very small in magnitude ($<1\%$) and therefore deemed insignificant (**Plate 4.11**). Similar to previous results, the zone of effect under a 1 in 50 year event was even smaller in extent than for the 1 in 1 year event, and the magnitude of change remained $<1\%$ of baseline conditions (**Plate 4.12**).

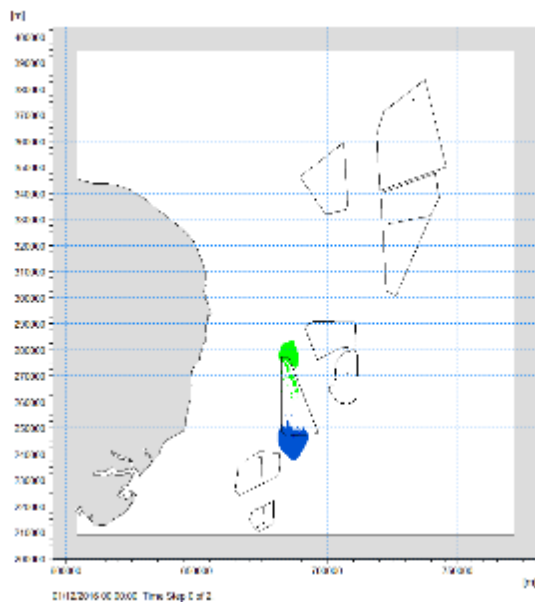

Plate 4:7: Percentage change in 1 in 1 year return period event (waves from N) due to the proposed East Anglia TWO project

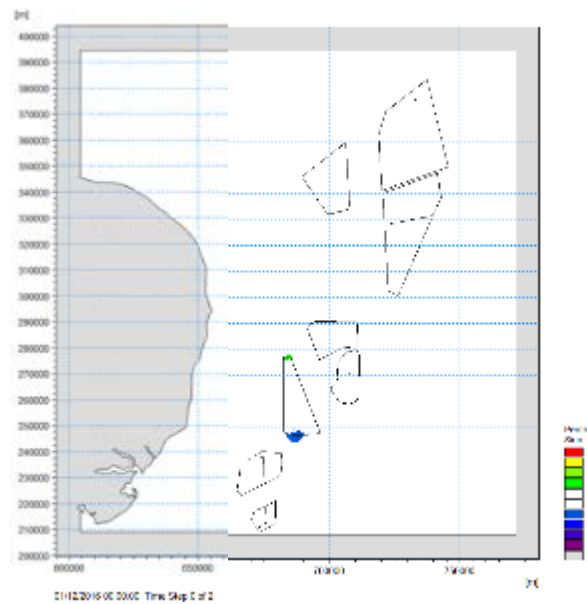

Plate 4:8: Percentage change in 1 in 50 year return period event (waves from N) due to the proposed East Anglia TWO project

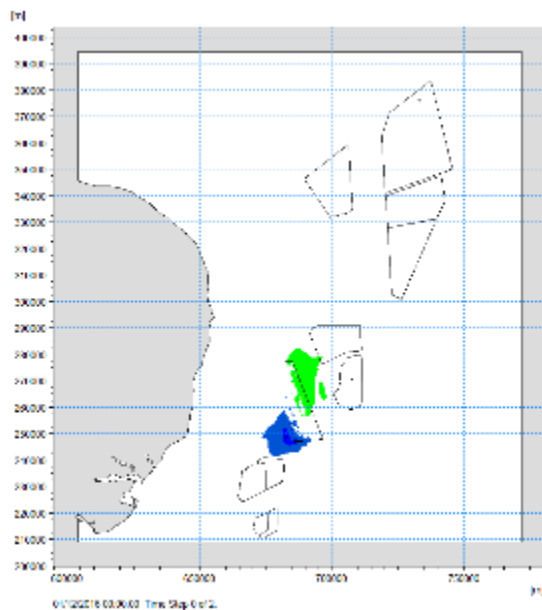

Plate 4:9: Percentage change in 1 in 1 year return period event (waves from NNE) due to the proposed East Anglia TWO project

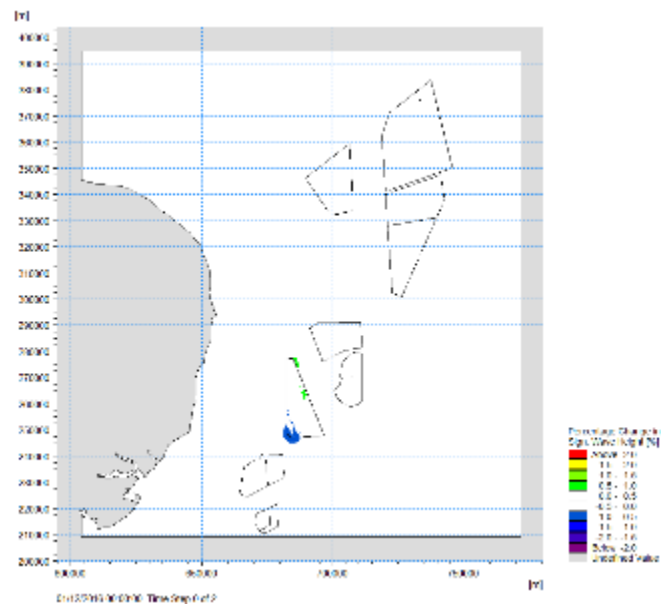

Plate 4:10: Percentage change in 1 in 50 year return period event (waves from NNE) due to the proposed East Anglia TWO project

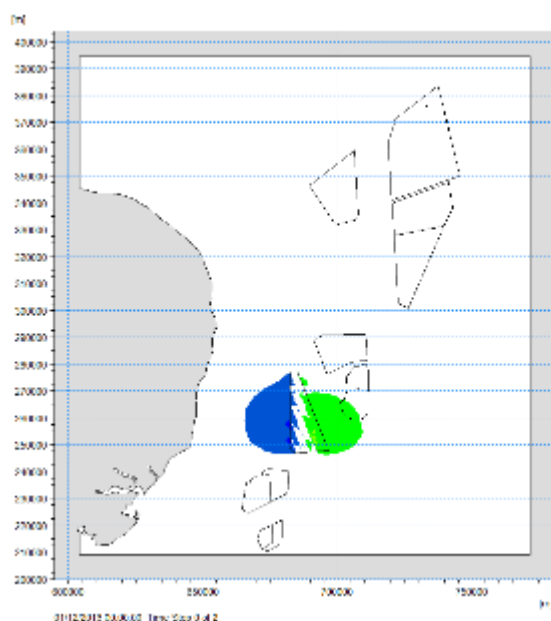

Plate 4:11: Percentage change in 1 in 1 year return period event (waves from E) due to the proposed East Anglia TWO project

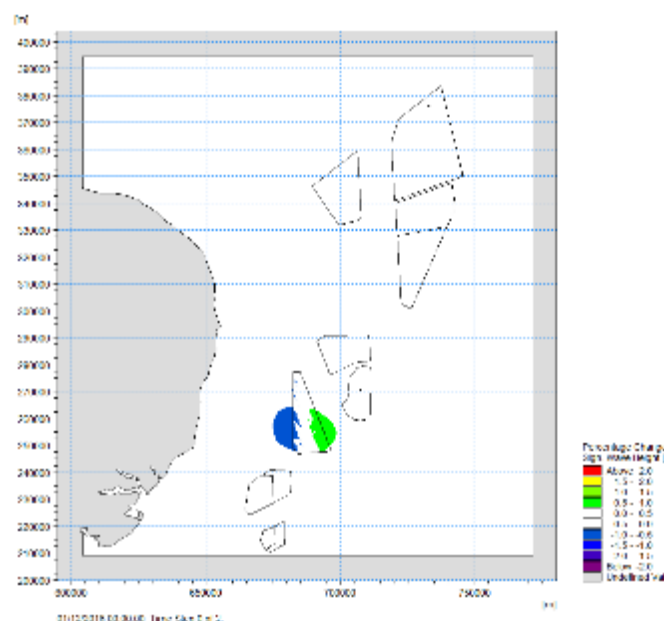

Plate 4:12: Percentage change in 1 in 50 year return period event (waves from E) due to the proposed East Anglia TWO project

4.1.3 Proposed East Anglia ONE North project

44. As was the case for the proposed East Anglia Project TWO project, the individual project modelling for the proposed East Anglia ONE North project comprised runs for 1 in 1 year and 1 in 50 year return period events from each of three directions, namely north, nor-northeast and east.
45. For waves approaching from due north, the zone of effect on baseline wave climate caused by the introduction of the proposed East Anglia ONE North project did impinge on the northern most section of the East Anglia ONE windfarm site, but only marginally so. Furthermore the magnitude of change in baseline wave height at this location was very small (<1%) and therefore deemed insignificant (**Plate 4.13**). Under a 1 in 50 year event the change was even smaller (<0.5%, **Plate 4.14**) and consequently was also deemed insignificant.
46. When modelled waves approached from nor-northeast, the zone of effect on baseline wave climate adopted a different alignment, being based along a more nor-northeast to south-southwest axis. However, the zone of effect did not impinge on the East Anglia TWO windfarm site and where changes were observed, closer to the East Anglia ONE North windfarm site, they were very small in magnitude (<1%) and therefore deemed insignificant (**Plate 4.15**). Under a 1 in 50 year event the change was even smaller (typically <0.5% %, **Plate 4.16**) and consequently was also deemed insignificant.

47. Under easterly offshore wave conditions (which have lower wave heights for the given return periods than waves from due north or nor-northeast), the zone of wave sheltering effect on the baseline wave climate extended due east from the East Anglia ONE North windfarm site, directly towards the shore. However, where the zone of effect marginally impinged upon the northern most section of the East Anglia TWO windfarm site the change in baseline wave climate was very small in magnitude (<1%) and therefore deemed insignificant (**Plate 4.17**). Under a 1 in 50 year event the change was even smaller in extent and remained <1% reduction of baseline conditions and therefore was also deemed insignificant (**Plate 4.18**).

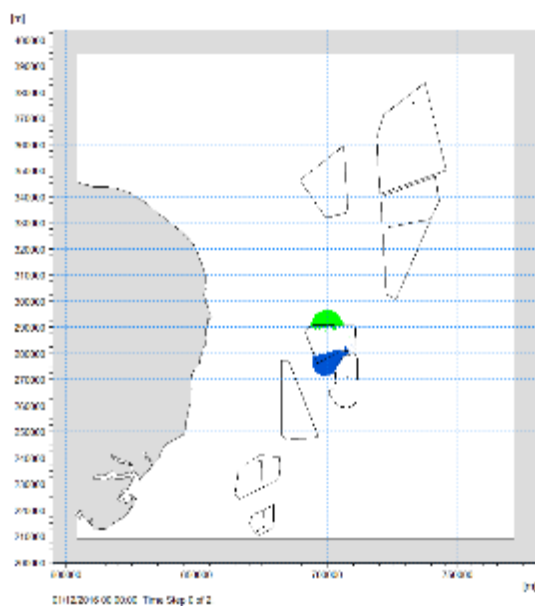

Plate 4:13: Percentage change in 1 in 1 year return period event (waves from N) due to East Anglia ONE North project

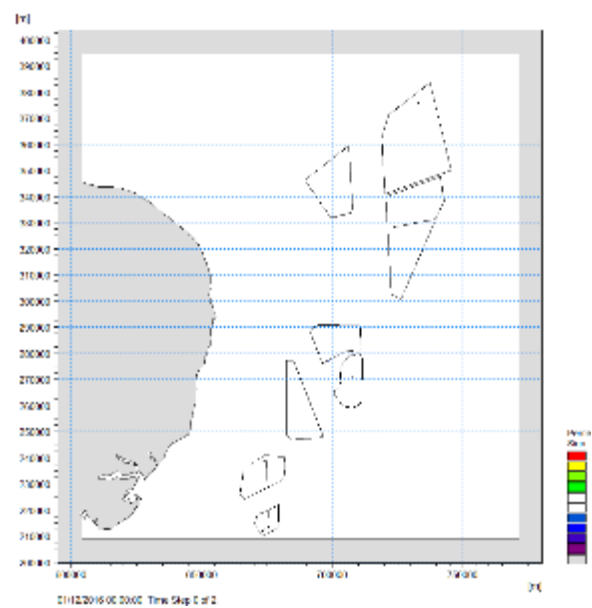

Plate 4:14: Percentage change in 1 in 50 year return period event (waves from N) due to East Anglia ONE North project

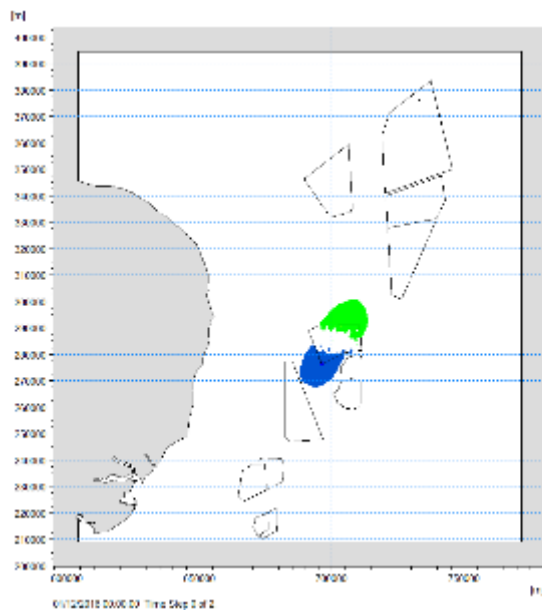

Plate 4:15: Percentage change in 1 in 1 year return period event (waves from NNE) due to East Anglia ONE North project

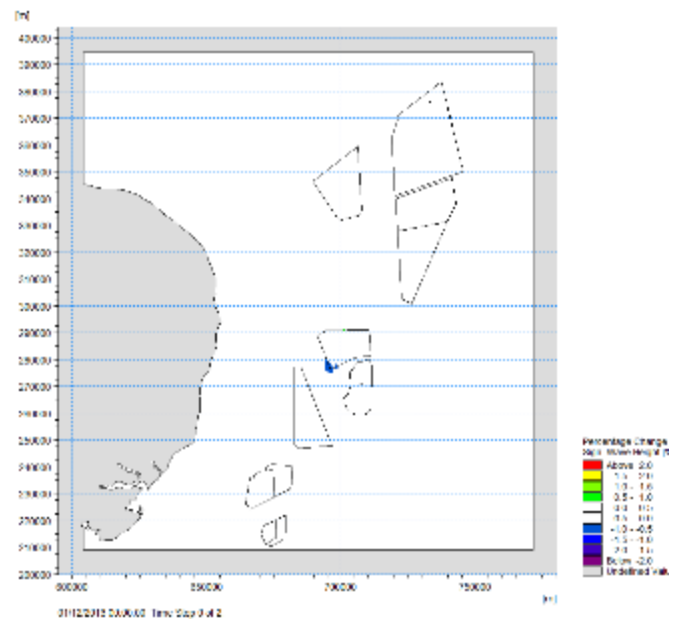

Plate 4:16: Percentage change in 1 in 50 year return period event (waves from NNE) due to East Anglia ONE North project

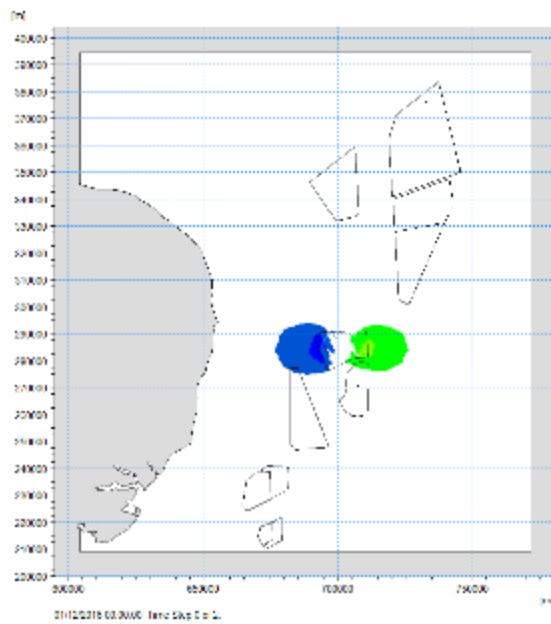

Plate 4:17: Percentage change in 1 in 1 year return period event (waves from E) due to East Anglia ONE North project

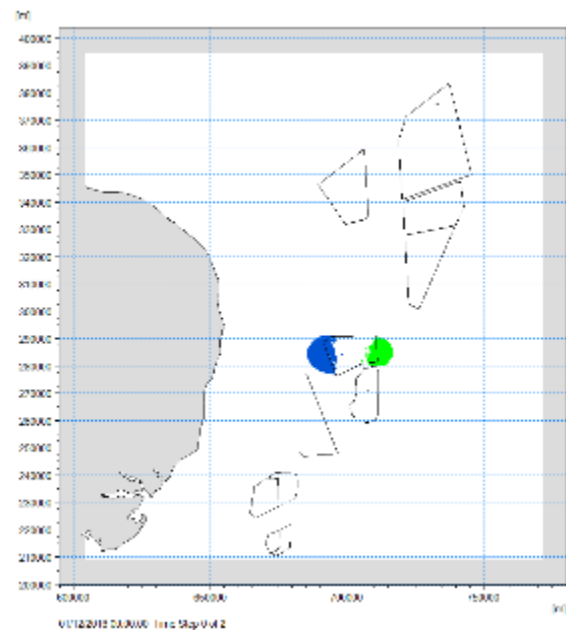

Plate 4:18: Percentage change in 1 in 50 year return period event (waves from E) due to East Anglia ONE North project

4.1.4 Cumulative assessments

48. The cumulative assessments were undertaken in two stages, primarily because establishing a single MIKE21 SW wave model over an extensive area of sea bed, with fine resolution grids over all windfarm projects to be included within the cumulative assessments, would have been computationally inefficient.
49. Instead, therefore, an **Auxiliary Wave Model** was set up to examine the potential for interactions between the Hornsea Offshore Wind Farm projects and the former East Anglia Zone.
50. Following this, the **Main Wave Model** was used to consider cumulative effects between the Norfolk Boreas, Norfolk Vanguard, East Anglia ONE, East Anglia ONE North, East Anglia TWO, East Anglia THREE, Greater Gabbard and Galloper windfarms.

4.1.4.1 Auxiliary Wave Model

51. Effects arising from Hornsea Projects 1, 2 and 3 on the former East Anglia Zone were tested for waves approaching from due north (N) and nor-northeast (NNE), under both 1 in 1 year and 1 in 50 year return period events.
52. **Plate 4:19** and **Plate 4:20** show the percentage changes in wave height due to the cumulative effects of Hornsea Projects 1, 2 and 3 for waves from due north during 1 in 1 year and 1 in 50 year return period events, respectively. **Plate 4.21** and **Plate 4.22** show equivalent results under these return period events for waves that approach from a north-northeast direction.
53. The effects under both approach directions are seen to extend over the greatest area under the lower return period event. This is due to the higher return period being associated with longer wave periods, which are less affected by the foundation structures. Also, all of the results show both a zone of wave sheltering in the 'down-wave' direction from the array and a zone of wave height increase caused by reflection off the structures in an 'up-wave' direction. Within the central area of each array, the combined effects effectively balance out and demonstrate no discernible change.
54. It is important to recognise that the magnitude of change in baseline wave height shown by these model tests is extremely small (typically <2%) and certainly less than the 5% threshold identified as being potentially significant for effects potentially arising on receptors. Indeed, if the legend was 'blanked' for any changes within $\pm 5\%$ of baseline wave heights then absolutely no change would be visible.
55. Furthermore, the zone of effect under the tests performed does not extend sufficiently so as to interact with the former East Anglia Zone, and therefore no

significant cumulative effects are identified as arising from Hornsea Projects 1, 2 and 3.

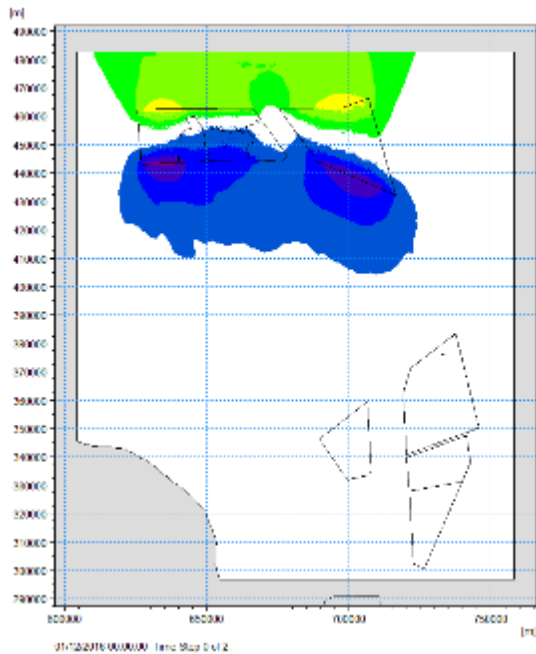

Plate 4:19: Percentage changes in baseline wave height arising cumulatively from Hornsea Project 1, Project 2 and Project 3 under a 1 in 1 year return period event (waves from N)

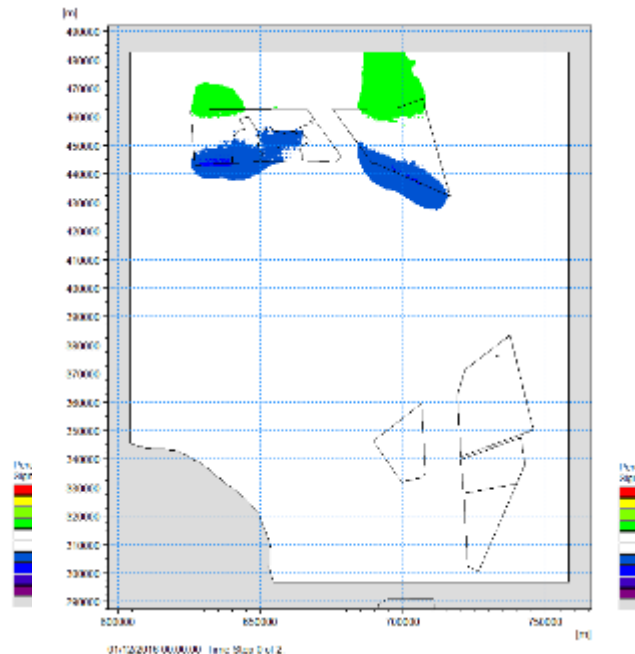

Plate 4:20: Percentage changes in baseline wave height arising cumulatively from Hornsea Project 1, Project 2 and Project 3 under a 1 in 50 year return period event (waves from N)

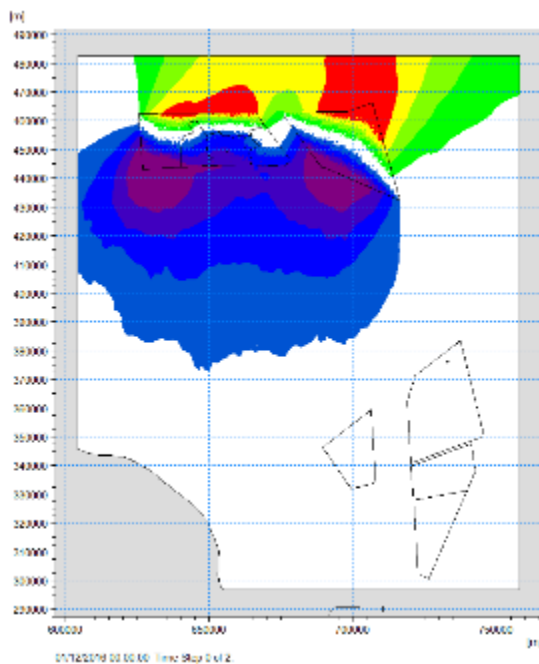

Plate 4:21: Percentage changes in baseline wave height arising cumulatively from Hornsea Project 1, Project 2 and Project 3 under a 1 in 1 year return period event (waves from NNE)

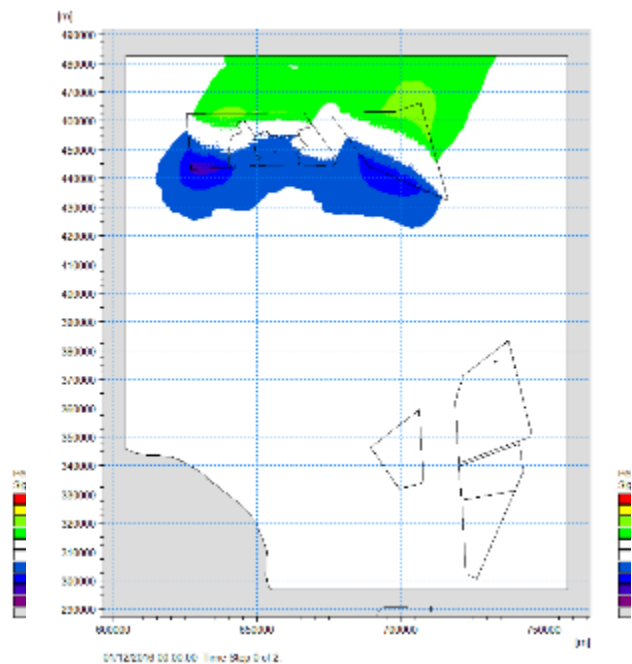

Plate 4:22: Percentage changes in baseline wave height arising cumulatively from Hornsea Project 1, Project 2 and Project 3 under a 1 in 50 year return period event (waves from NNE)

56. These findings are consistent with the published findings from wave modelling that was previously undertaken by HR Wallingford associated with both Hornsea Project 1 and Hornsea Project 2. Those assessments are well documented in the following reports:
- Hornsea Offshore Wind Farm Project 1 – Environmental Statement (ES) Volume 2 – Offshore. Chapter 1 Marine Processes (SMart Wind, July 2013);
 - Hornsea Offshore Wind Farm Project 1 – ES Volume 2 – Offshore Annexes. Annex 5.1.2 Wave Modelling (SMart Wind, July 2013);
 - Hornsea Offshore Wind Farm Project 2 – ES Volume 2 – Offshore. Chapter 1 Marine Processes (SMart Wind, January 2015); and
 - Hornsea Offshore Wind Farm Project 2 – ES Volume 2 – Offshore Annexes. Annex 5.1.2 Wave Modelling (SMart Wind, January 2015).
57. Note that Hornsea Project 3 is currently in its pre-planning stage and therefore no publicly available information is available on assessment of effects on the wave regime from this project, either alone or cumulatively with other Hornsea projects. Hornsea Project 4 is deemed too far west to have any potential effect on the North Sea area off the eastern Norfolk and Suffolk coast and therefore was excluded from the cumulative assessments.

58. For both Hornsea Project 1 and Hornsea Project 2, near-field wave modelling was previously undertaken in their respective EIAs using the ARTEMIS wave model to investigate wave transmission past wind turbines and associated infrastructure foundations.
59. Far-field wave modelling was then undertaken as part of the respective EIAs for the Hornsea projects using the SWAN wave model. For Hornsea Project 1, the worst case scenario considered 341 structures founded on GBS at a minimum spacing of 924m whilst for Hornsea Project 2 it considered 360 wind turbines founded on GBS at a minimum spacing of 810m. These scenarios are more onerous than the conditions used in cumulative modelling for the present study, since there has been refinement of those projects since their respective EIAs were produced, reducing the number of wind turbines in each project.
60. The previous modelling for both Hornsea Project 1 and Hornsea Project 2 considered various return period events (ranging from 0.1 year to 100 year return periods) and the greatest effects in plan extent were found to be associated with high-frequency, low-intensity events. However, under all events modelled the zone of effect within which changes in wave height were below 5% remained relatively close to each project's individual area and in all cases did not extend to interact with the projects within the former East Anglia Zone.
61. Hornsea Project 2 and Hornsea Project 1 were also modelled cumulatively using the above approaches in the EIAs for those projects and similar results were found. This demonstrates that there is no potential cumulative effect arising from these two projects upon the northern boundary of the former East Anglia Zone.
62. There is therefore great confidence in the conclusion that there is no significant cumulative effect arising from the Hornsea projects upon the former East Anglia Zone because mutually corroborative results have been determined from two totally independent wave modelling studies.

4.1.4.2 Main Wave Model

63. The **Main Wave Model** was used to consider effects arising cumulatively from the Norfolk Boreas, Norfolk Vanguard, East Anglia ONE, East Anglia ONE North, East Anglia TWO, East Anglia THREE, Greater Gabbard and Galloper windfarms. The model was run for waves approaching from due north (N), north-northeast (NNE) and East (E), under both 1 in 1 year and 1 in 50 year return period events.
64. **Plate 4:23** and **Plate 4:24** show the percentage changes in wave height due to the cumulative effects of these projects for waves from due north during 1 in 1 year and 1 in 50 year return period events, respectively. **Plate 4:25** and **Plate**

4:26 respectively show equivalent results under these return period events for waves that approach from a nor-northeast direction, whilst **Plate 4:27** and **Plate 4:28** respectively show equivalent results for these return periods under waves from due East.

65. The effects under all approach directions are seen to extend over the greatest area under the lower (1 in 1 year) return period event for the reasons previously discussed associated with the higher (1 in 50 year) return period events having longer wave periods, which are less affected by the foundation structures.

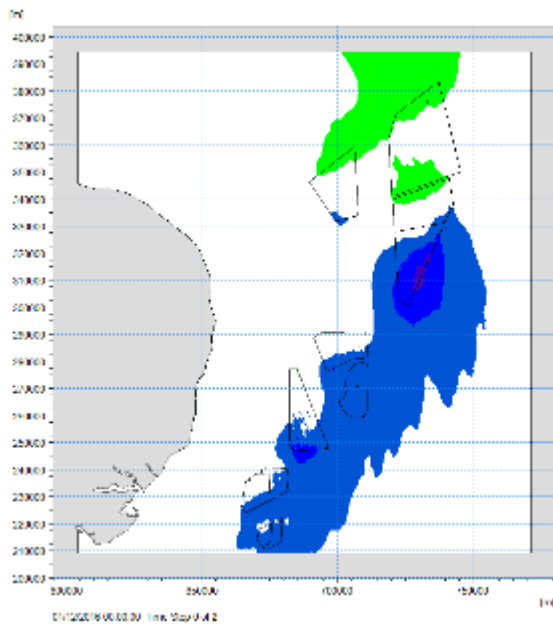

Plate 4:23: Percentage changes in baseline wave height arising cumulatively from all other projects under a 1 in 1 year return period event (waves from N)

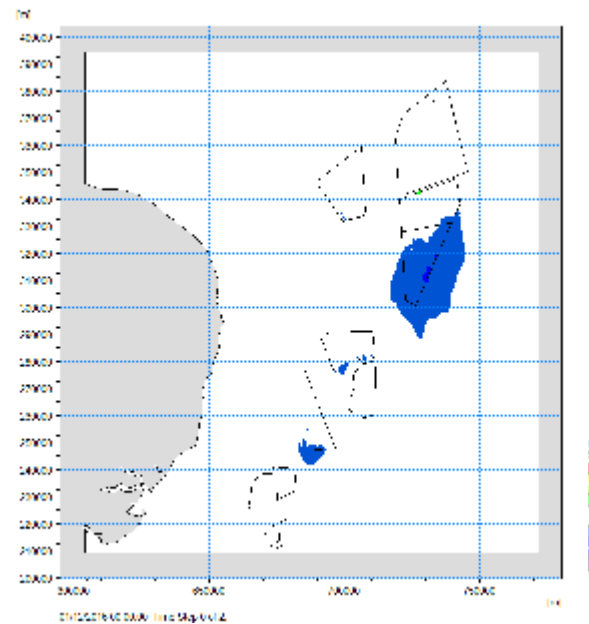

Plate 4:24: Percentage changes in baseline wave height arising cumulatively from all other projects under a 1 in 50 year return period event (waves from N)

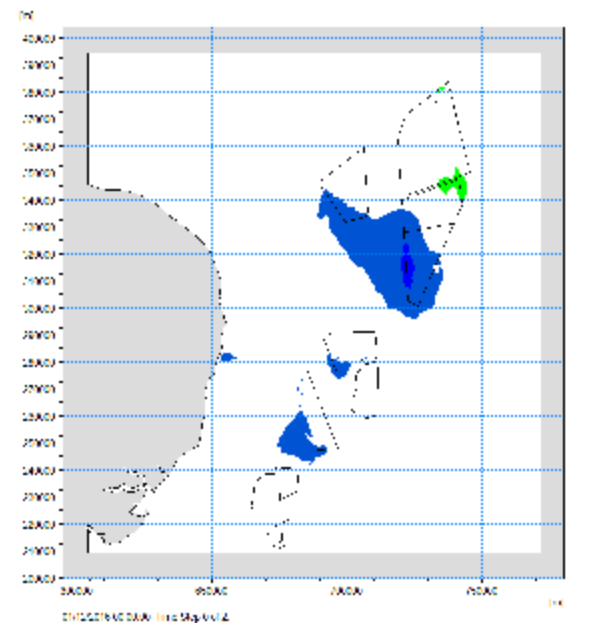
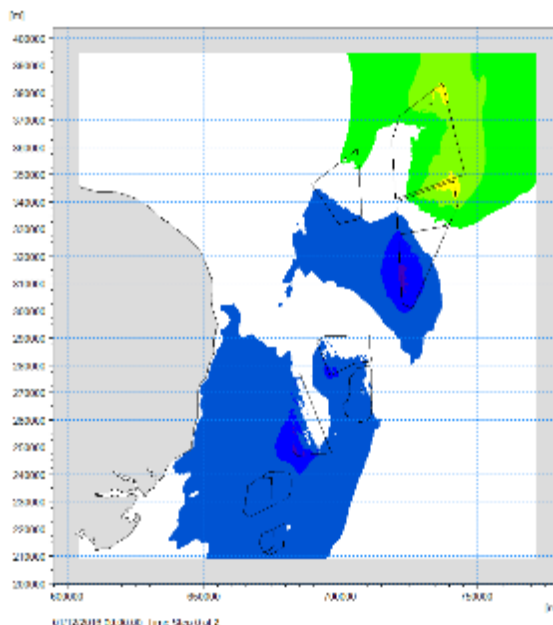

Plate 4:25: Percentage changes in baseline wave height arising cumulatively from all other projects under a 1 in 1 year return period event (waves from NNE)

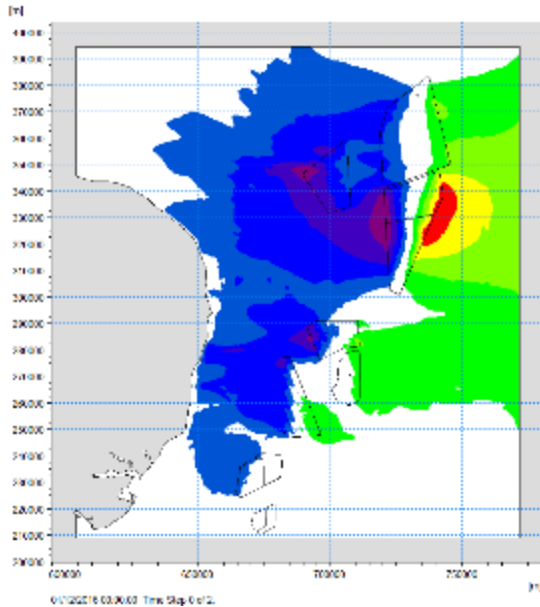

Plate 4:26: Percentage changes in baseline wave height arising cumulatively from all other projects under a 1 in 50 year return period event (waves from NNE)

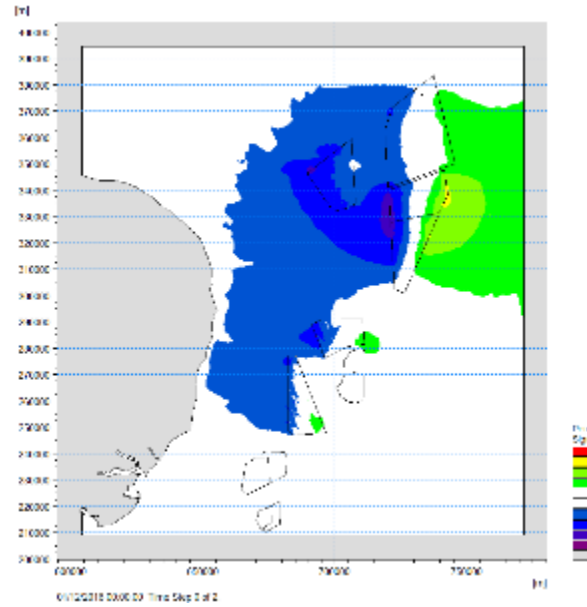

Plate 4:27: Percentage changes in baseline wave height arising cumulatively from all other projects under a 1 in 1 year return period event (waves from E)

Plate 4:28: Percentage changes in baseline wave height arising cumulatively from all other projects under a 1 in 50 year return period event (waves from E)

66. Results show that the greatest effects, in terms of percentage change in baseline significant wave height, occur under the more frequent return period (i.e. 1 in 1 year). This can be seen by comparing **Plate 4:23**, **Plate 4:25** and **Plate 4:27** for the 1 in 1 year event under different approach directions with **Plate 4:24**, **Plate 4:26** and **Plate 4:28** which show the changes under corresponding approach directions under the 1 in 50 year event. This finding is consistent with the results of the individual East Anglia TWO or East Anglia ONE North project modelling and the cumulative assessment modelling of the Hornsea Projects.
67. Also apparent is that the greatest percentage change in baseline significant wave height occurs with the lower incident wave events, namely those from due east, as shown in **Plate 4:27** and **Plate 4:28** compared with the waves from due north (**Plate 4:23** and **Plate 4:24**) or nor'-northeast (**Plate 4:25** and **Plate 4:26**).
68. Under the 1 in 1 year event with waves approaching from due north (**Plate 4:23**), the zone of effect from the Norfolk Boreas, Norfolk Vanguard East and East Anglia THREE grouping of projects does impinge upon part of the East Anglia ONE North and all of the East Anglia ONE grouping. In turn, this also impinges on the southern-most part of the proposed East Anglia TWO project and

ultimately parts of the Greater Gabbard and Galloper projects. In reaching this extent, the zone of influence also impinges upon the location of some of the identified receptor groups for the marine geology, oceanography and physical processes topic, namely: nearby non-designated sandbanks (marginally). However, the magnitude of change in baseline significant wave heights across these zones of extended influence is <1%. Even on the south-eastern boundary of East Anglia THREE, where the effect appears greatest, the change in baseline significant wave heights remains <2%. Therefore, despite a comparatively larger zone of influence from the projects cumulatively, rather than individually, the magnitude of change under the 1 in 1 year return period event from due north remains insignificant for the cumulative assessments.

69. Under the 1 in 50 year event with waves approaching from due north (*Plate 4.22*), the zone of effect from the Norfolk Boreas, Norfolk Vanguard East and East Anglia THREE grouping of projects does not impinge upon the proposed East Anglia ONE North project and East Anglia ONE grouping or exhibit any cumulative effect further afield. Consequently, the extent of change under the 1 in 50 year return period event from due north remains insignificant for the cumulative assessments.
70. Under the 1 in 1 year event with waves approaching from nor'-northeast (***Plate 4:25***), the zone of effect from the cumulative modelling adopts a more NNE-SSE alignment and thus tends to be obliquely directed towards the Suffolk coastline. The zone of effect from the Norfolk Boreas, Norfolk Vanguard West, Norfolk Vanguard East and East Anglia THREE grouping of projects does not impinge upon the proposed East Anglia ONE North project and East Anglia ONE grouping. However, the effect from the proposed East Anglia ONE North project and East Anglia ONE does partially impinge upon part of the proposed East Anglia TWO project and the Greater Gabbard and Galloper projects. The combined effect from, particularly, the proposed East Anglia TWO project, Greater Gabbard and Galloper projects then approaches the Suffolk coastline. In reaching this extent, the zone of influence impinges upon the location of some of the identified receptor groups for the marine geology, oceanography and physical processes topic, namely: Norfolk Natura 2000 sea bed (marginally), Suffolk Natura 2000 sea bed (marginally), nearby non-designated sandbanks and Suffolk coast. However, the magnitude of change in baseline significant wave heights across these zones of extended influence, including at the coast, is <1%. Where the magnitude of change is greatest, at the northern boundaries of Norfolk Boreas and Norfolk Vanguard East and the eastern boundary of East Anglia THREE, the change in baseline significant wave heights remains <2%. Therefore, despite a comparatively larger zone of influence from the projects cumulatively, rather than individually, and despite the zone of influence covering several of the identified receptors (including the Suffolk coast) the magnitude of

- change under the 1 in 1 year return period event from nor'-northeast remains insignificant for the cumulative assessments.
71. Under the 1 in 50 year event with waves approaching from nor'-northeast (**Plate 4:26**), the zone of effect from the Norfolk Boreas, Norfolk Vanguard West, Norfolk Vanguard East and East Anglia THREE grouping of projects does not impinge upon the proposed East Anglia ONE North project and East Anglia ONE grouping or exhibit any cumulative effect further afield. Consequently, the extent of change under the 1 in 50 year return period event from due north remains insignificant for the cumulative assessments.
72. Under the 1 in 1 year event with waves approaching from due east (**Plate 4:27**), the zone of effect from the Norfolk Boreas, Norfolk Vanguard East and East Anglia THREE grouping of projects does impinge upon the Norfolk Vanguard West project and areas of the sea bed further west still towards the east Norfolk coastline. Similarly, the cumulative effect from the proposed East Anglia ONE North project, East Anglia ONE, proposed East Anglia TWO project, Greater Gabbard and Galloper projects extends due west towards the Suffolk coast. In reaching this extent, the zone of influence impinges upon the location of some of the identified receptor groups for the marine geology, oceanography and physical processes topic, namely: Norfolk Natura 2000 sea bed, Suffolk Natura 2000 sea bed, nearby non-designated sandbanks, Norfolk coast and Suffolk coast. However, the magnitude of change in baseline significant wave heights across these zones of extended influence is <1% where it reaches the location of the identified receptors and is mostly <2% elsewhere. It is only to the immediate west (reduction) and/or east (increase) of Norfolk Vanguard West, Norfolk Vanguard East, East Anglia THREE, proposed East Anglia ONE North project and proposed East Anglia TWO project (marginally) that the change in baseline significant wave height exceeds 2%, and in all these areas the change remains <5%. Therefore, despite a comparatively larger zone of influence from the projects cumulatively, rather than individually, and despite the zone of influence covering several of the identified receptors (including the Suffolk and Norfolk coasts) the magnitude of change under the 1 in 1 year return period event from due east remains insignificant for the cumulative assessments.
73. Under the 1 in 50 year event with waves approaching from due east (**Plate 4:28**), the zone of effect is slightly lesser in spatial extent than under the 1 in 1 year condition and the magnitude of change remains mostly ,1%, with changes locally to some project boundaries reaching 2%. Consequently, the extent of change under the 1 in 50 year return period event from due north remains insignificant for the cumulative assessments.
74. These findings are consistent with the results from previous assessments of other wind farm projects that were provided in their respective EIAs. For East

Anglia ONE (East Anglia Offshore Wind Limited, 2012) changes to the wave regime due to the presence of the foundation structures were modelled using Delft3D-SWAN both individually for East Anglia ONE and cumulatively between East Anglia ONE and Galloper. The worst case scenario considered was the use of 240 GBS for East Anglia ONE (although in practice, jackets have subsequently been adopted and considerably fewer wind turbines (only 102) are now under construction).

75. For the worst case conditions assessed in that EIA, the maximum reductions in wave height for the individual modelling appeared within, or along the boundary of, the array. These reached up to 20% locally during large storm events within the array (but that model considered only the wave shadow effects and not the wave reflection effects of the foundations, which would have 'counter-balanced' some of the local effects), but under typical conditions reductions were less than 2% at a distance of 40km from the array. There was no measureable effect on wave conditions at the shore, although there was predicted to be a reduction of up to ~5% at the non-designated sand banks to the southwest of East Anglia ONE. This reduction reduced to less than ~2% for the banks contained within the Haisborough, Hammond and Winterton SAC. Since these banks will continue to experience waves for sectors other than those which will cross the East Anglia ONE project, it was concluded in the EIA that these bank systems were not expected to be affected by the anticipated changes to baseline wave conditions. Overall, therefore, the modelled changes in the baseline wave regime from the East Anglia ONE project individually were concluded to be not significant for the worst case conditions that were assessed (which as previously described are more onerous than the project that actually is being constructed).
76. The wave shadow cast by East Anglia ONE (under the more onerous worst case conditions assessed) did extend to Galloper, although the percentage changes in baseline wave heights were very small (<5%). However, it was still necessary to consider whether any cumulative effects from East Anglia ONE, Galloper and Greater Gabbard (and other Greater Thames projects) could potentially affect the wave climate at the coast. Consequently, cumulative wave modelling was undertaken and revealed that changes at the coast were of a magnitude that would be immeasurable in practice and well within the range of natural variability in baseline conditions. It was therefore concluded that there were no significant cumulative effects from East Anglia ONE, Galloper and Greater Gabbard (and other Greater Thames projects) on the marine geology, oceanography and physical processes.
77. For the East Anglia THREE EIA (East Anglia Offshore Wind Limited, 2015), a desk-based review of over 30 EIAs from other offshore wind farm developments

was undertaken specifically to understand how assessments of the changes to the wave regime had been undertaken, and to collate and synthesise their findings. Building upon this understanding, a 'zone of potential influence' on the baseline wave regime was depicted. This was influenced by modelling outputs from East Anglia ONE, and an understanding of the baseline wave regime at the East Anglia THREE site. In order to reflect the uncertainty associated with this approach, a conservative zone was developed and used to determine whether any effect would reach other windfarm sites or any sensitive receptors. The work concluded that there would be no impact on the identified receptors for marine geology, oceanography and physical processes based on the envisaged changes in the wave regime, either from East Anglia THREE individually or from East Anglia THREE with other projects cumulatively.

78. Modelling for the Greater Gabbard EIA (Greater Gabbard Offshore Winds Limited, 2005) showed there to be no expected change to the existing wave conditions from wind turbines on concrete GBS foundations further afield than in the immediate vicinity of the windfarm site. Thus no effects were expected along any of the coastlines found within the Thames region. The localised changes within the immediate vicinity of the array were shown as wave height reductions, with typical reductions being of the order of 0.1m. Such a reduction was considered insignificant, only representing a 4% reduction in baseline conditions. Results from the Greater Gabbard modelling were used in the Galloper EIA (Galloper Wind Farm Limited, 2011) to conclude that it was not anticipated that the (by then installed) Greater Gabbard project would alter the wave climate in the proposed Galloper project site beyond that experienced by natural variations and that there would be no far-field effects of significance on the wave climate.

5 Conclusions

79. The offshore waves which have the greatest potential to cause effects between those wind farm projects which have been screened-in to cumulative assessments upon identified marine geology, oceanography and physical process topic receptors are from between the north and east sectors.
80. Of these, waves from due north (N) are of the greatest dominance in terms of both frequency and magnitude of wave events. Waves from north-northeast (NNE) or east-northeast (ENE) are less frequent but, collectively, represent an important overall contribution to the offshore wave climate. Waves from due east (E) are considerably less frequent and lower in magnitude, but any changes in waves from this approach direction have the potential to directly affect the coastline and nearshore sea bed receptors.
81. Local scale wave modelling using a DIFFRACT model has confirmed that of the different foundation options tested, GBS represent the worst case foundation type in terms of potential effect on the baseline wave climate for any given water depth. For a given foundation type and size, greatest effects on wave climate are proven in shallower water depths and towards lower wave periods.
82. Regional scale wave modelling using a MIKE21 Spectral Wave model has confirmed that the effects on the baseline wave climate from each of the proposed East Anglia TWO and East Anglia ONE North projects individually generally cover a small spatial extent and the magnitude of modelled changes in significant wave height is typically <1% only a short distance away from each array. Changes of this magnitude were identified in both a down-wave direction (reductions in significant wave height caused by wave shadow effects) and an up-wave direction (increases in significant wave height caused by wave reflection off foundation structures).
83. Modelling of Hornsea Project 1, Hornsea Project 2 and Hornsea Project 3 cumulatively demonstrated that changes in the baseline wave regime do not extend to the former East Anglia Zone. This is in keeping with the findings from the EIAs for Hornsea Project 1 and Hornsea Project 2. (Note that Hornsea Project 3 is currently in its pre-planning stage and therefore no publicly available information is available on assessment of effects on the wave regime from this project, either alone or cumulatively with other Hornsea projects.)
84. Modelling of the Norfolk Boreas, Norfolk Vanguard East, Norfolk Vanguard West, East Anglia ONE, proposed East Anglia ONE North project, proposed East Anglia TWO project, East Anglia THREE, Greater Gabbard and Galloper wind farms cumulatively demonstrated that the zone of effect arising from the

cumulative assessments was considerably greater in spatial extent than that arising from projects individually. The zone of effect from various groupings of these projects under particular wave approach directions and return periods can impinge upon other groupings of projects included within the cumulative assessments and, in turn, can extend to reach some of the sensitive receptors identified for the marine geology, oceanography and physical process topic. However, the magnitude of change in significant wave height in areas within the zone of effect is typically <1%, increasing in most situations to <2% locally to array boundaries. In the occasional situations where changes local to the array boundaries exceed 2%, they are always less than the 5% change in significant wave height agreed with Cefas as being the threshold for significance in terms of potential effects.

85. Based upon the findings from the wave modelling, it is concluded that the proposed East Anglia TWO and East Anglia ONE North projects will not cause significant changes to the baseline wave climate, either as individual projects or cumulatively with other windfarm projects in this area of the North Sea. As a consequence, there will be no significant effects upon the receptors identified as being sensitive to changes in the baseline wave climate for the marine geology, oceanography and physical process topic. This conclusion is in keeping with the findings of the cumulative assessments from the EIAs for Hornsea Project 1, Hornsea Project 2, East Anglia ONE and East Anglia THREE (with other projects still being in pre-planning at the present time).

6 References

Cefas, 2017. *Review of the East Anglia TWO and East Anglia ONE North Windfarms Physical Processes Method Statement Consultation 1*. Letter from Cefas to MMO dated 8th September 2017.

East Anglia Offshore Wind Limited, 2012. *East Anglia ONE Environmental Statement Volume 2 Offshore. Chapter 6 Marine Geology, Oceanography and Physical Processes*. November 2012.

East Anglia Offshore Wind Limited, 2015. *East Anglia THREE Environmental Statement Volume 1. Chapter 7 Marine Geology, Oceanography and Physical Processes*. November 2015.

Forewind. 2013. *Dogger Bank Creyke Beck Environmental Statement Chapter 9 Marine Physical Processes*. August 2013.

Forewind. 2014. *Dogger Bank Teesside A & B Environmental Statement Chapter 9 Marine Physical Processes*. March 2014.

Greater Gabbard Offshore Winds Limited, 2005. *Greater Gabbard Offshore Wind Farm Environmental Statement*. October, 2005.

Galloper Wind Farm Limited, 2011. *Galloper Wind Farm Project Environmental Statement. Chapter 9 Physical Environment*. October, 2011.

Marine Management Organisation (MMO), 2017. *Re: East Anglia TWO and East Anglia ONE North – Individual Project and Cumulative Wave Modelling Briefing Note*. Letter from MMO to Scottish Power Renewables dated 15th November 2017.

Orbicon & Royal HaskoningDHV. 2014. *Horns Rev 3 Offshore Wind Farm Technical Report no. 3. Hydrography, Sediment Spill, Water Quality, Geomorphology and Coastal Morphology*. April 2014.

Royal HaskoningDHV & Vattenfall, 2017. *Norfolk Vanguard Offshore Wind Farm Preliminary Environmental Information. Marine Geology, Oceanography and Physical Processes*. October 2017.

Scottish Power Renewables, 2017a. *East Anglia ONE North and East Anglia TWO Wind Farms Evidence Plan – Physical Processes Method Statement*. March 2017.

Scottish Power Renewables, 2017b. *East Anglia TWO and East Anglia ONE North – Individual Project and Cumulative Wave Modelling Briefing Note*. November 2017.

SMart Wind, 2013. *Hornsea Offshore Wind Farm Project One Environmental Statement Volume 2 – Offshore. Chapter 1 Marine Processes*, July 2013.

SMart Wind, 2013. Hornsea Offshore Wind Farm Project One Environmental Statement – Volume 5 Offshore Annexes. Annex 5.1.2 Wave Modelling. July 2013.

SMart Wind, 2015. Hornsea Offshore Wind Farm Project Two Environmental Statement Volume 2 – Offshore. Chapter 1 Marine Processes, January 2015.
SMart Wind, 2015. Hornsea Offshore Wind Farm Project Two Environmental Statement – Volume 5 Offshore Annexes. Annex 5.1.2 Wave Modelling. January 2015.

Annex 1 Offshore wave climate

Background

86. This Appendix describes the wave extremes analysis that has been undertaken for the proposed East Anglia TWO and East Anglia ONE North projects.

Wave Data

87. In order to undertake the wave extremes analysis, Met Office hindcast data covering a period of 37 years was purchased. **Figure 1** shows the location of the hindcast model data point that has been used. This location was chosen because it is located at the top right corner of the MIKE21-SW wave model that was used to determine the impact of the proposed windfarm developments on the baseline wave climate.

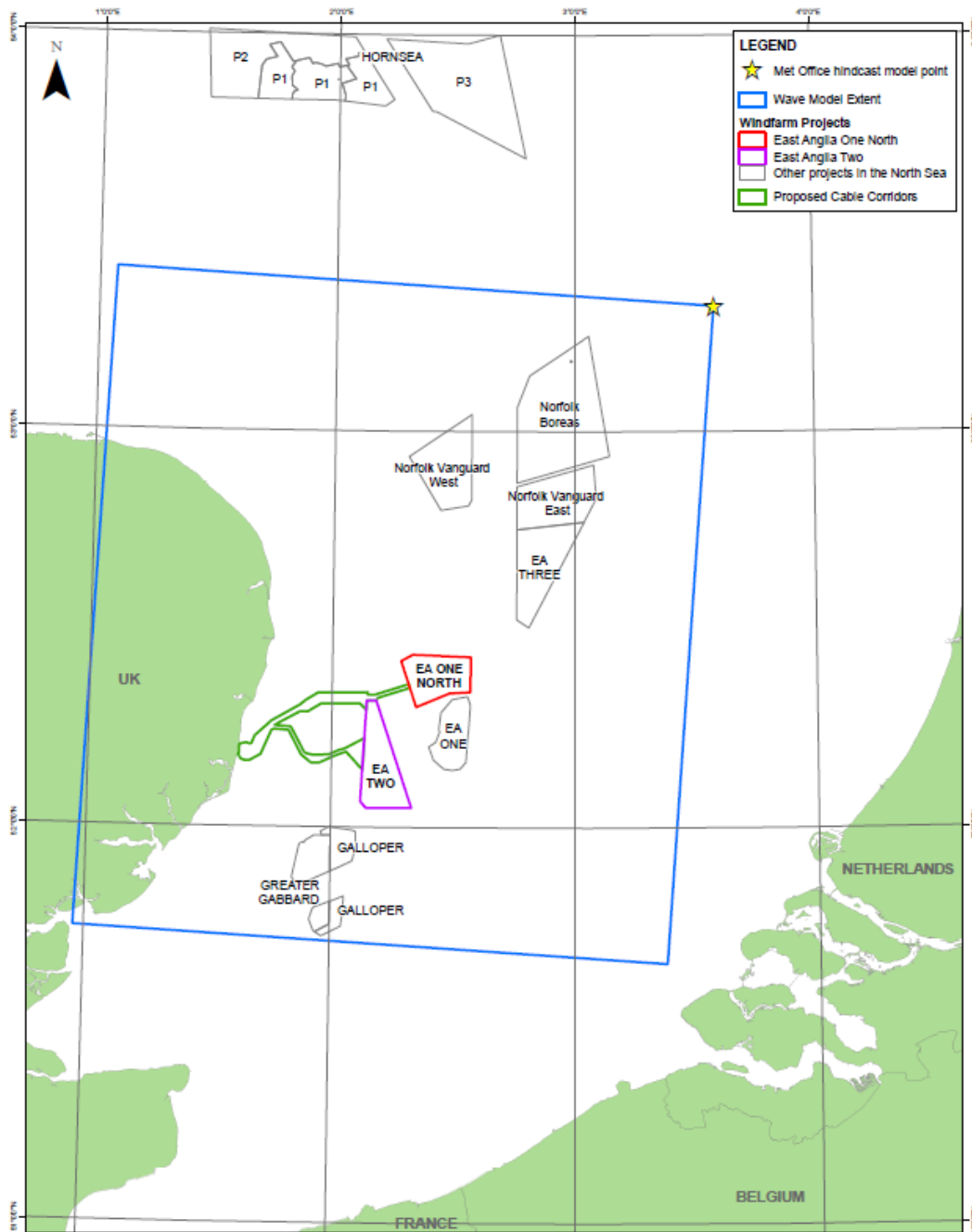

Figure 1: Location of Met Office hindcast model data point and wave model extent

88. The Met Office hindcast data covers the period from 01/01/1980 to 31/08/2017. The data for the period from 01/01/1980 to 31/12/2001 is given at 3 hourly intervals, whilst the data for the period of 01/01/2002 to 31/08/2017 is given at 1 hourly intervals. **Figure 2a** shows the wave rose generated using the Met Office hindcast data, with **Figure 2b** showing the same data at different significant wave height bands and further directional sector resolutions for improved breakdown.

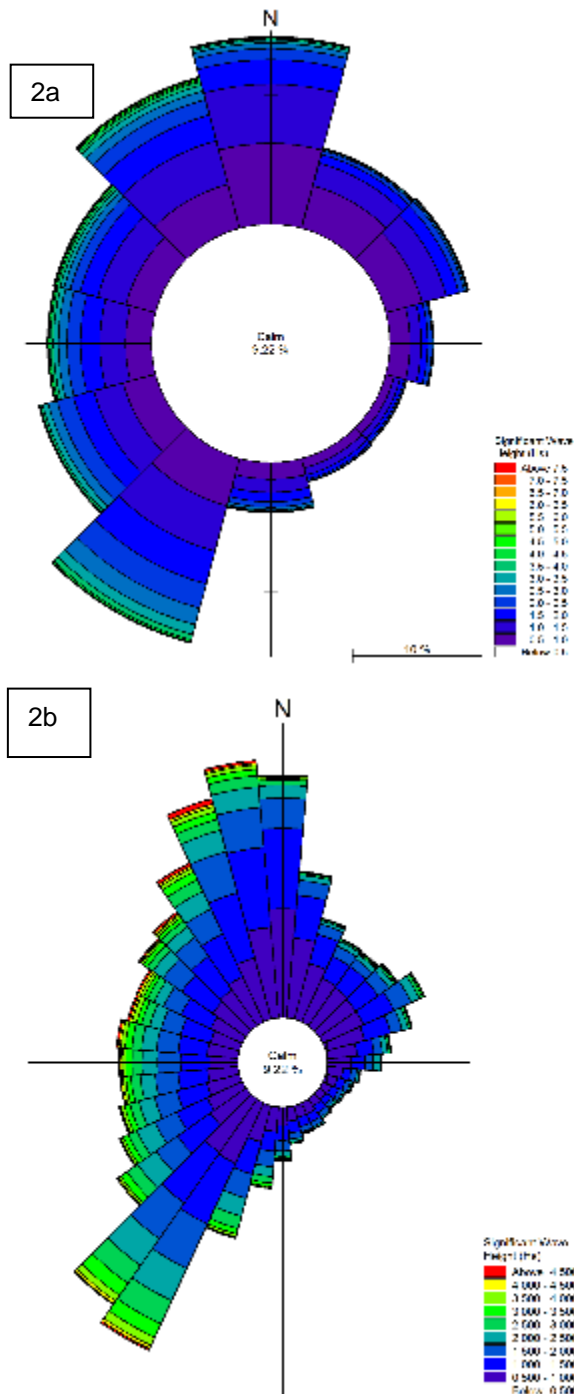

Figure 2a & b: Wave rose of hindcase model data

89. The waves which have the greatest potential to cause cumulative effects between projects upon identified receptors are from the North to East sectors. Of these, waves from due north (N) are of the greatest dominance in terms of both frequency and magnitude of wave events. Waves from nor-northeast (NNE) or east-northeast (ENE) are less frequent and waves from due east (E) are less frequent still.

Wave Extremes Analysis

90. The following wave direction sectors were considered for the wave extremes analysis due to their relevance for the windfarm developments:
- North (N): -15 to 15 degrees
 - North-North-East (NNE): 15 to 45 degrees
 - East-North-East (ENE): 45 to 75 degrees
 - East (E): 75 to 115 degrees
91. For each year of the hindcast data set the five largest events of significant wave height (Hs) were identified for each wave direction sector.
92. The GEV wave extremes analysis software was used to calculate the wave extremes. **Figures 3 - 6** show the result graphs. For each wave direction sector two methods of calculating the results are used, EV1 and EV2. For the wave directions, N and NNE method EV1 has been selected as the best fit, whilst for wave directions ENE and E method EV2 has been selected.

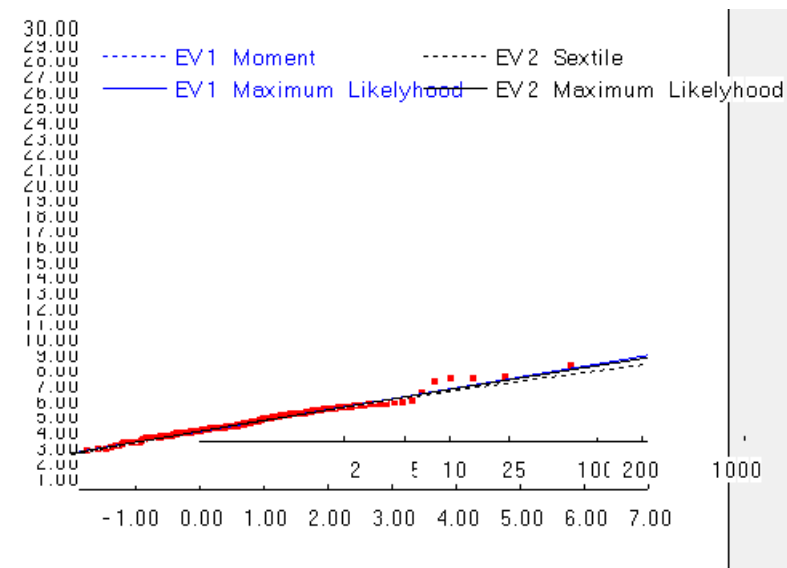

Figure 3: Wave Direction North (N)

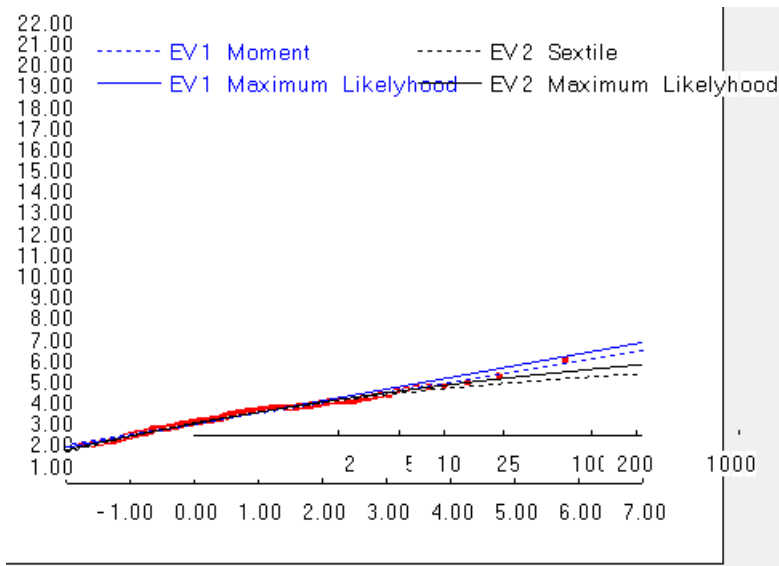

Figure 4: Wave Direction North-North-East (NNE)

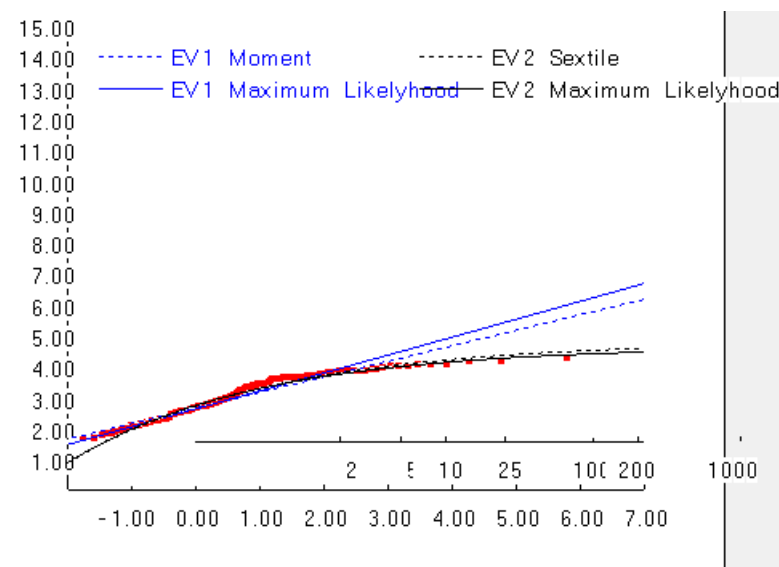

Figure 5 Wave Direction East-North-East (ENE)

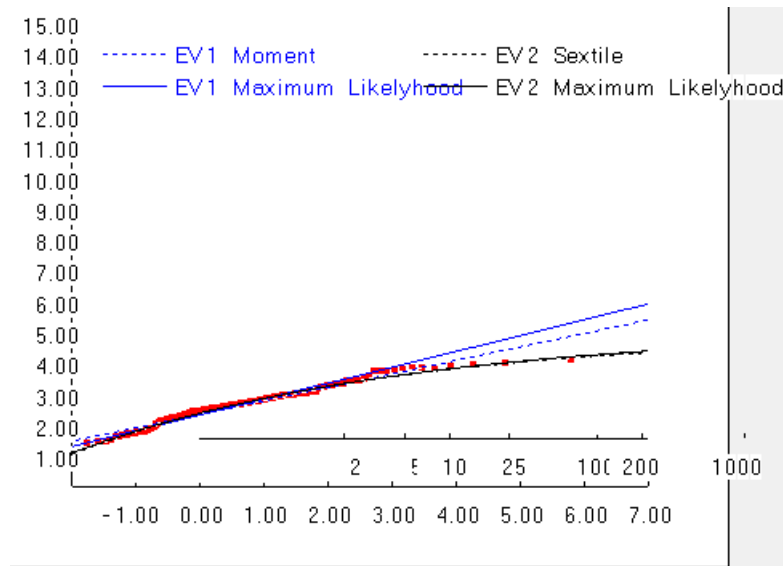

Figure 6: Wave Direction East (E)

93. Extreme waves were calculated for two return periods, namely 1 in 1 year and 1 in 50 years. **Table 1** shows the extreme significant wave height for these return periods and for the two calculation formulae. The highest wave height for each return period and wave direction (shown in bold in **Table 1**) has been used in the wave model.

Table 1: Extreme waves for 1 in 1 year and 1 in 50 year events

	EV1 (Gumbel) Estimated by moment	EV1 (Gumbel) Estimated by Maximum Likelihood	EV1 (Gumbel) Estimated by moment	EV1 (Gumbel) Estimated by Maximum Likelihood
North	4.77	4.77	7.58	7.59
North-North-East	3.55	3.62	5.54	5.84
Wave Direction	Hs (m) for 1 in 1 year event		Hs (m) for 1 in 50 year event	
	EV2 (Gumbel) Estimated by Sextiles	EV2 (Gumbel) Estimated by Maximum Likelihood	EV2 (Gumbel) Estimated by Sextiles	EV2 (Gumbel) Estimated by Maximum Likelihood
East-North-East	3.48	3.47	4.42	4.32
East	3.04	3.04	4.10	4.14

Annex 2 Local scale wave modelling using DIFFRACT

Background

94. This Appendix describes the local scale wave modelling that has been undertaken using the DIFFRACT model.

Introduction

95. Wave energy will be redistributed when waves interact with offshore wind turbine foundations. Usually, the dominant effects include reflection and diffraction of waves caused by the larger dimensional structures. Other causes for the redistribution/loss of wave energy are wave-structure friction and flow separation behind the structures. However, friction effects are difficult to estimate in many cases, whilst flow separation is usually assumed to be important for situations where Keulegan Carpenter (KC) numbers are greater than 6. Although it has also been argued that flow separation may occur at lower KC numbers (Trulsen and Teigen, 2002), only effects of reflection and diffraction are considered in the present report since these are deemed to be the dominant effects.

Methodology

Definition of wave reflection coefficient

96. Considering the energy flow through the wind turbine foundations it seems reasonable to set up an energy balance based on **Figure 1**. The relations between incoming energy $\hat{E}_{f,I}$, reflected energy $\hat{E}_{f,R}$ and transmitted energy $\hat{E}_{f,T}$ can be written as:

$$\hat{E}_{f,R} = \hat{E}_{f,I} - \hat{E}_{f,T} \quad (1)$$

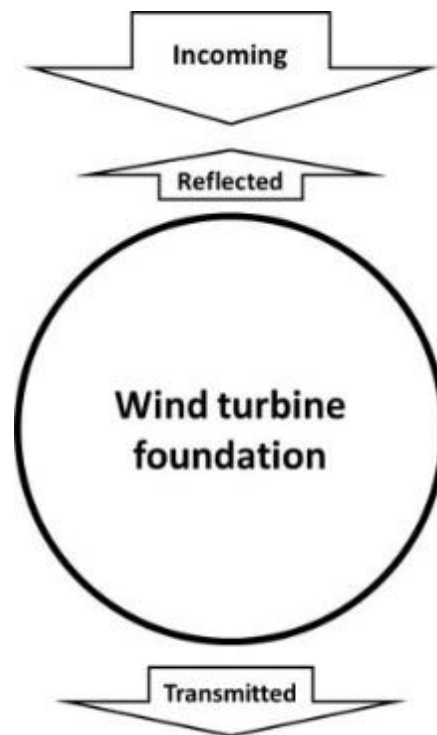

Figure 1 Redistributions of wave energy due to wind turbine foundation

97. Under first-order assumption, wave energy flux for waves over a plane sea bed can be expressed by:

$$E_f = \frac{1}{T} \int_0^T \int_{-h}^0 p^+ u dz dt \quad (2)$$

98. Where:

- u is the horizontal velocity of water particle
- T is the wave period
- h is water depth.
- For undisturbed waves (incoming waves), the energy flux can be expressed as:

$$E_{f,I} = \frac{1}{16} \rho g H^2 c \left(1 + \frac{2kh}{\sinh(2kh)} \right) \quad (3)$$

99. Where:

- ρ is the mass density of water
- g is gravitational acceleration
- H is the wave height
- c is the wave celerity = ω/k (here $\omega=2\pi/T$)
- k is the wave number = $2\pi/L$ (here L is the wave length)

100. The transmitted energy flux $\hat{E}_{f,T}$ can be calculated by integrating the wave energy flux from the foundation surface to infinity perpendicular to the wave direction, which is $\hat{E}_{f,T} = \int_{-\infty}^{\infty} E_{f,T} dy$

(4)

101. Usually, the wind turbine foundations are axisymmetric structures and only half the plane is needed in the calculations. So the transmitted energy $\hat{E}_{f,T}$ can be obtained from the integration from CL(y=0) to infinity.

$$102. \quad \hat{E}_{f,T} = 2 \int_{CL}^{\infty} E_{f,T} dy = 2 \int_{CL}^{\infty} \left[\frac{1}{T} \int_0^T \int_{-h}^0 p^+ u dz dt \right] dy \quad (5)$$

103. The wave reflection coefficient can be defined as:

$$104. \quad C = \frac{\hat{E}_{f,I} - \hat{E}_{f,T}}{E_{f,I}} = 2 \frac{\int_{CL}^{\infty} \left\{ E_{f,I} - \left[\frac{1}{T} \int_0^T \int_{-h}^0 p^+ u dz dt \right] \right\} dy}{E_{f,I}} \quad (6)$$

105. This parameter indicates the equivalent reflection effects of the wind turbine foundation (and it is in metres).

Calculation of wave reflection coefficient

106. Clearly, dynamic pressure p^+ and horizontal velocity u are needed for calculating the wave reflection coefficient. Under the first-order assumption using potential flow theory, the expressions for calculating excess pressure and horizontal velocity can be written as:

$$\bullet \quad p^+ = Re[i\omega\rho\varphi e^{-i\omega t}] \quad (7)$$

$$\bullet \quad u = Re\left[\frac{\partial\varphi}{\partial x} e^{-i\omega t}\right] \quad (8)$$

107. Where:

- $Re[]$ denotes the real parts of complex numbers
- φ is the first-order velocity potential in fluid domain.
- In wave diffraction problems, velocity potential φ can be decomposed into:
- $\varphi = \varphi_I + \varphi_D$ (9)
- Where:
- φ_I is incident potential which has analytical expression
- φ_D is diffraction potential which can be obtained by solving the boundary value problem of wave-structure interactions.

108. A convenient way to get the diffraction velocity potential φ_D , and the total velocity potential is using potential flow solvers in frequency domain. In the

present report, a potential flow solver DIFFRACT has been used to analyse wave-structure interactions.

109. The computational program DIFFRACT has been developed to calculate linear and second order wave diffraction from three-dimensional arbitrary-shaped fixed or floating structures under unidirectional (Walker et al., 2006; Zang et al. 2006) and directional spread input regular waves (Zang et al., 2005) and random wave groups (Walker et al. 2008; Zang et al., 2009). A wide range of benchmarking tests have been performed to validate the implemented solution algorithms and the numerical code against published results.
110. The mathematical background of DIFFRACT is similar to that which has also been used in the computational program WAMIT. However, there are also some different features in DIFFRACT. In this implementation of the Boundary Element Method, the body surface, internal water plane and outer free surface for both linear and second order analysis are discretized into quadratic elements (Eatock Taylor and Chau, 1992). The directional spreading can be considered for incident waves (Zang et al., 2005). In the present version of the code, partial discontinuous elements have been adopted to remove the irregular frequencies and more details of the related method can be found in the paper of Sun et al. (2008). The effects of rigid/flexible mechanical connections can be predicted for multiple floating bodies by using DIFFRACT (Sun et al., 2011 and 2012).
111. More details on the program and the areas that DIFFRACT has been applied to, are provided in the references.

Foundations and corresponding meshes

112. Three types/dimensions of wind turbine foundations (one GBS and two monopiles) in different water depths have been considered and more information on the scenarios considered can be found in Table 1.
113. The details of the GBS foundation and numerical meshes used in the diffraction calculations for 30m, 40m, 50m, 60m and 70m of water depth are shown in Figures 2 to 11.
114. Diameters of monopile #1 and #2 are $D=6.5\text{m}$ and $D=12.0\text{m}$ respectively. Corresponding meshes are shown in **Figures 12** and **13**.

Table 1 Wind turbine foundations (one GBS and two monopiles) in different water depths

Water depth (m)	GBS	Monopile #1	Monopile #2
20		●	●
30	●	●	●

Water depth (m)	GBS	Monopile #1	Monopile #2
40	●	●	●
50	●	●	●
60	●		
70	●		

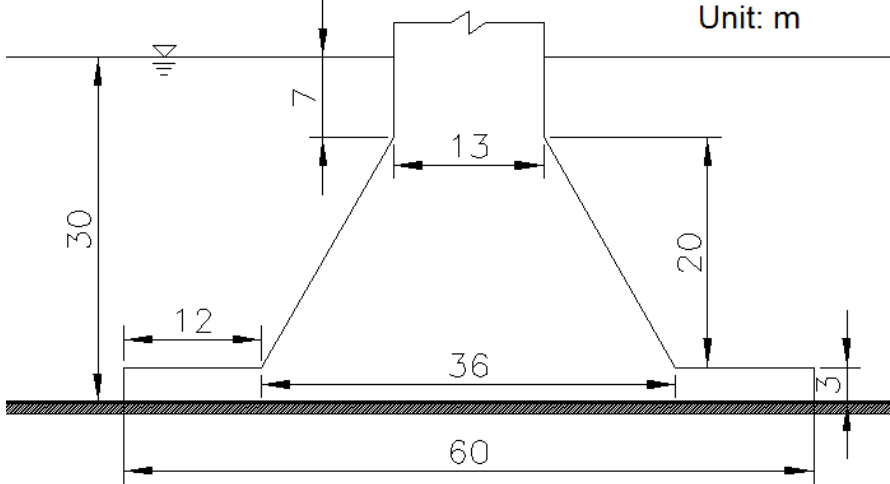

Figure 2 GBS foundation in water depth of 30 m

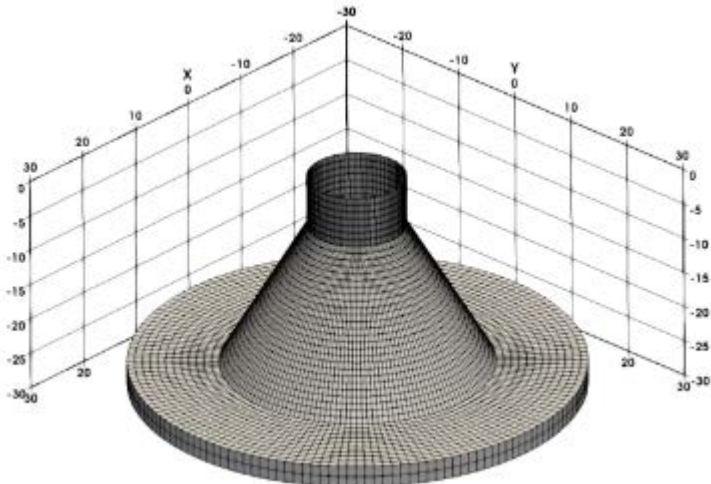

Figure 3 Numerical mesh for GBS foundation in water depth of 30 m

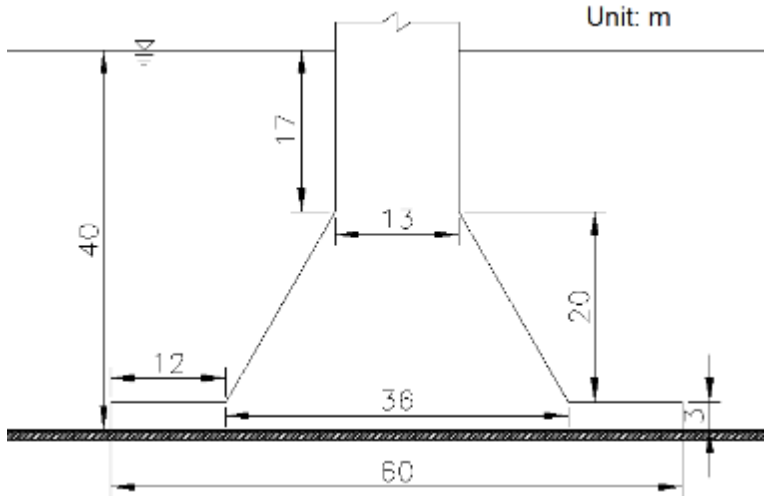

Figure. 4 GBS foundation in water depth of 40 m

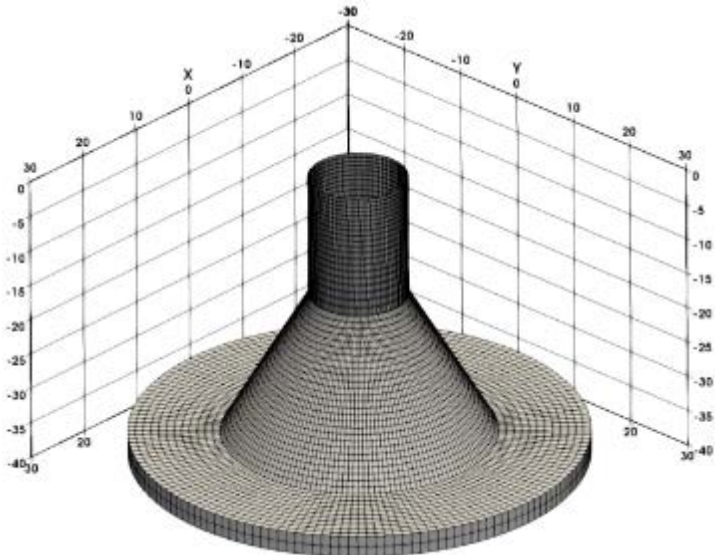

Figure. 5 Numerical mesh for GBS foundation in water depth of 40 m

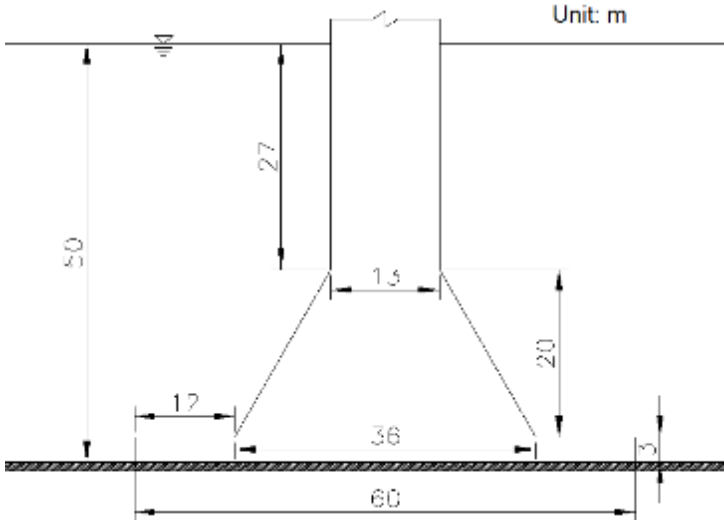

Figure 6 GBS foundation in water depth of 50 m

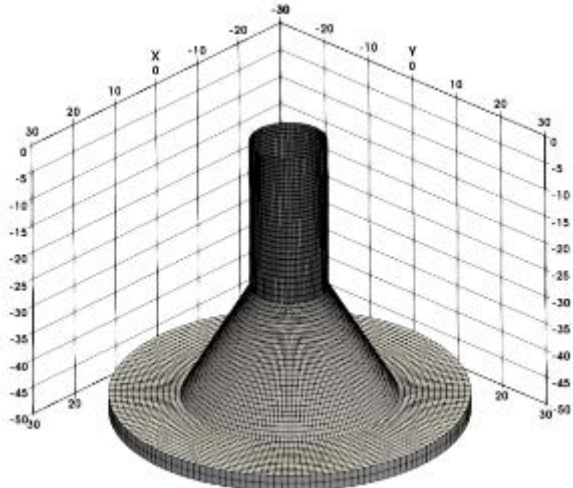

Figure 7 Numerical mesh for GBS foundation in water depth of 50 m

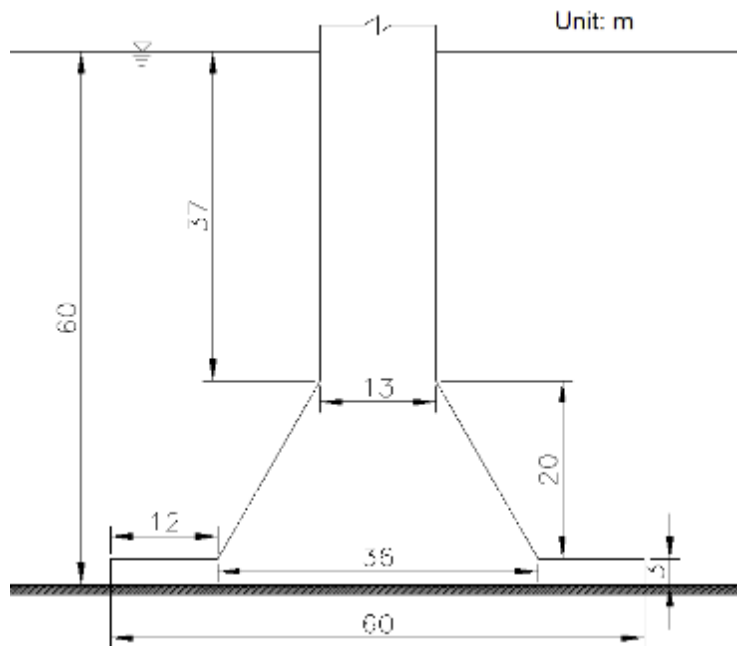

Figure 8 GBS foundation in water depth of 60 m

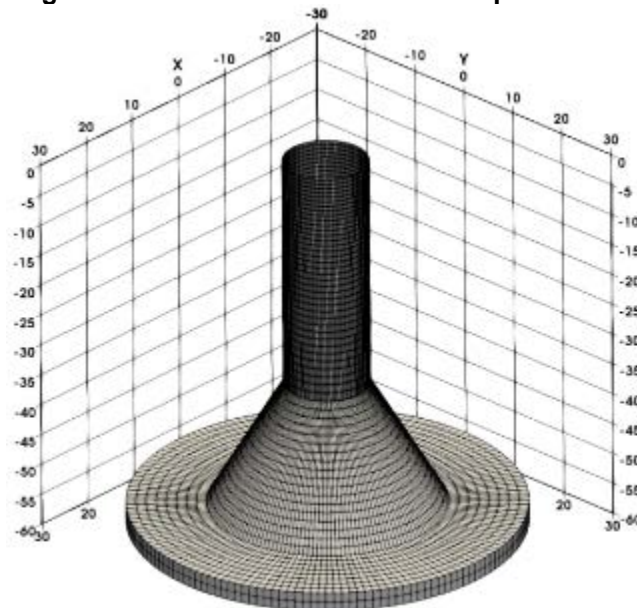

Figure 9 Numerical mesh for GBS foundation in water depth of 60 m

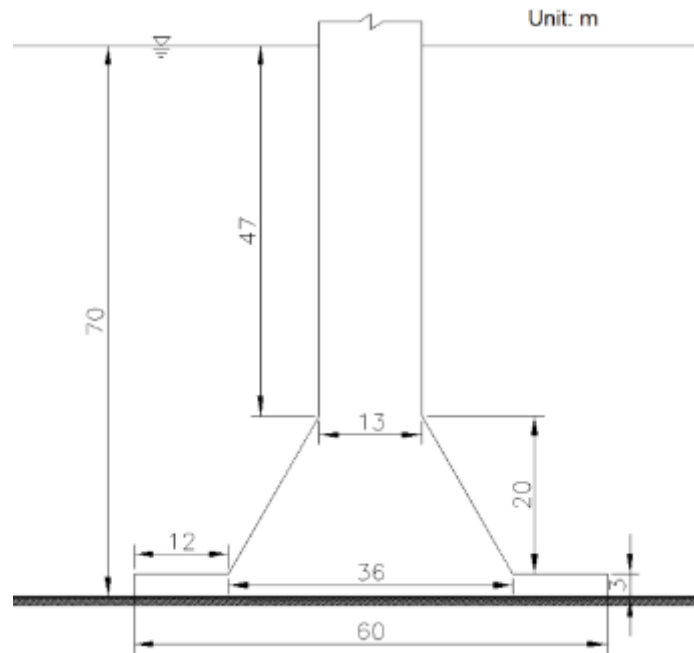

Figure 10 GBS foundation in water depth of 70 m

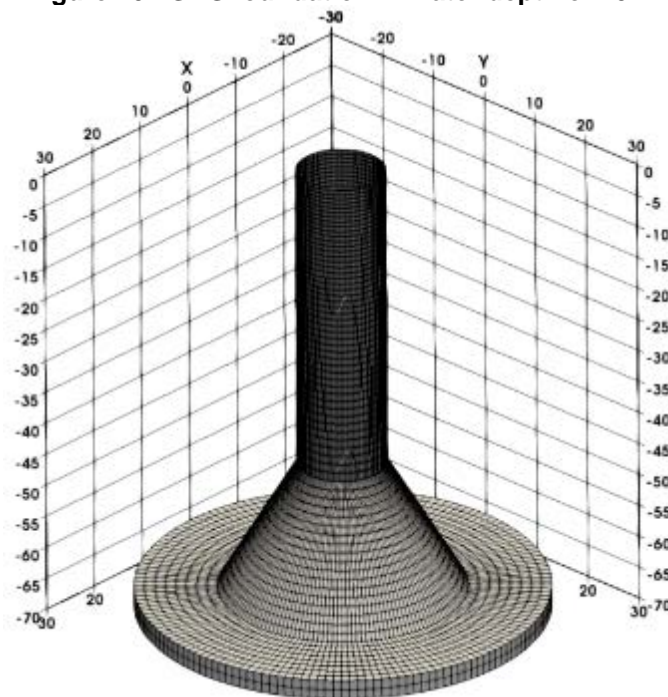

Figure 11 Numerical mesh for GBS foundation in water depth of 70 m

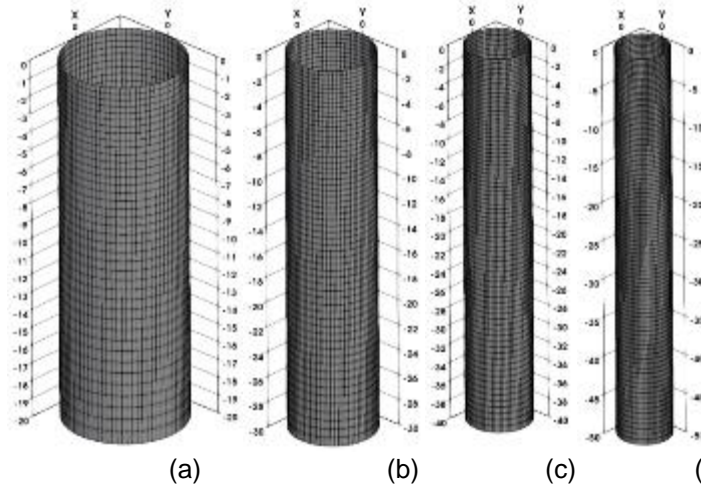

Figure 12 Numerical mesh for monopile #1 (D =6.5m) in different water depths
(a) 20m (b) 30m (c) 40m (d) 50m

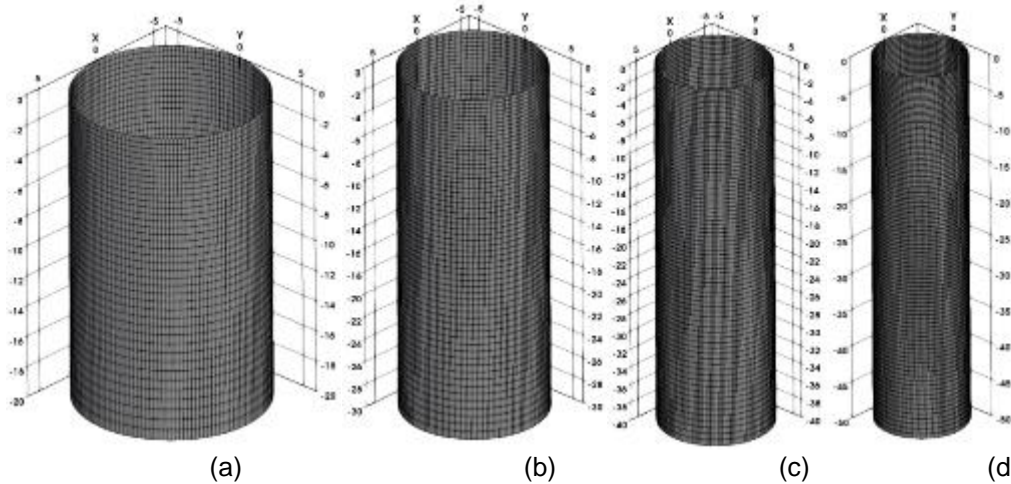

Figure 13 Numerical mesh for monopile #2 (D =12m) in different water depths
(a) 20m (b) in 30m (c) in 40m (d) in 50m

Results of wave reflection coefficients

115. The results of wave reflection coefficients for GBS foundation and monopiles are presented in the **Table 3** to **Table 5** and the corresponding graphs can be found in **Figure 14** to **Figure 19**.
116. It is reasonable that there is less reflection when longer waves pass the foundations.

Table 3 Wave reflection coefficients for GBS foundations in different water depths

Wave period (s)	Water depth (m)				
	30	40	50	60	70
2.0	8.577	8.303	8.115	7.792	7.533
3.0	8.847	8.705	8.634	8.443	8.315
4.0	9.526	9.299	9.209	9.120	9.029
5.0	10.961	10.377	10.291	10.223	10.153
6.0	9.764	8.918	8.321	8.261	8.204
7.0	6.793	5.553	5.399	5.348	5.328
8.0	4.509	3.283	3.063	2.983	2.963
9.0	3.361	2.036	1.782	1.659	1.638
10.0	2.545	1.567	1.070	0.898	0.858
11.0	2.131	1.151	0.648	0.438	0.364
12.0	1.677	0.863	0.381	0.147	0.037
13.0	1.486	0.651	0.204	0.037	0.009
14.0	1.206	0.496	0.088	0.035	0.001
15.0	0.979	0.377	0.005	0.005	0.001
16.0	0.798	0.287	0.001	0.001	0.001
17.0	0.542	0.217	0.001	0.001	0.001
18.0	0.416	0.162	0.001	0.001	0.001
19.0	0.272	0.117	0.001	0.001	0.001
20.0	0.237	0.083	0.001	0.001	0.001
21.0	0.215	0.050	0.001	0.001	0.001
22.0	0.152	0.028	0.001	0.001	0.001
23.0	0.093	0.103	0.001	0.001	0.001
24.0	0.077	0.034	0.001	0.001	0.001
25.0	0.027	0.018	0.001	0.001	0.001

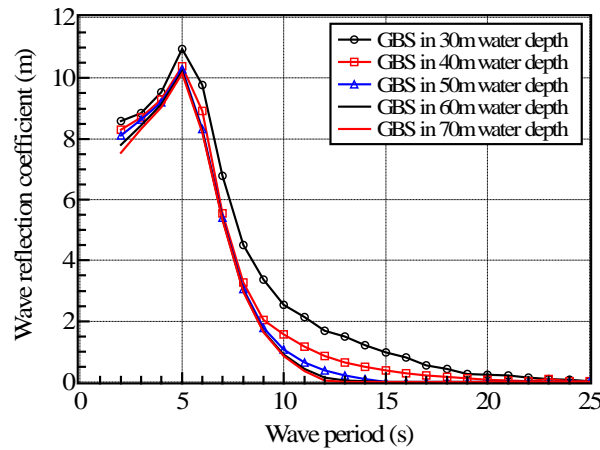

Figure 14 Wave reflection coefficients for GBS foundations in different water depths

Table 4 Wave reflection coefficients for monopile #1 in different water depths

Wave period (s)	Water depth (m)			
	20	30	40	50
2.0	4.234	4.147	4.057	3.969
3.0	4.786	4.726	4.665	4.604
4.0	4.747	4.711	4.662	4.611
5.0	2.621	2.406	2.383	2.345
6.0	1.148	1.140	1.061	1.055
7.0	0.705	0.636	0.645	0.509
8.0	0.437	0.334	0.322	0.340
9.0	0.299	0.182	0.139	0.142
10.0	0.223	0.099	0.032	0.008
11.0	0.174	0.051	0.010	0.002
12.0	0.141	0.018	0.002	0.001
13.0	0.114	0.009	0.001	0.001
14.0	0.091	0.001	0.001	0.001
15.0	0.069	0.001	0.001	0.001
16.0	0.045	0.001	0.001	0.001
17.0	0.018	0.001	0.001	0.001
18.0	0.005	0.001	0.001	0.001
19.0	0.001	0.001	0.001	0.001
20.0	0.001	0.001	0.001	0.001
21.0	0.001	0.001	0.001	0.001
22.0	0.001	0.001	0.001	0.001
23.0	0.001	0.001	0.001	0.001
24.0	0.001	0.001	0.001	0.001
25.0	0.001	0.001	0.001	0.001

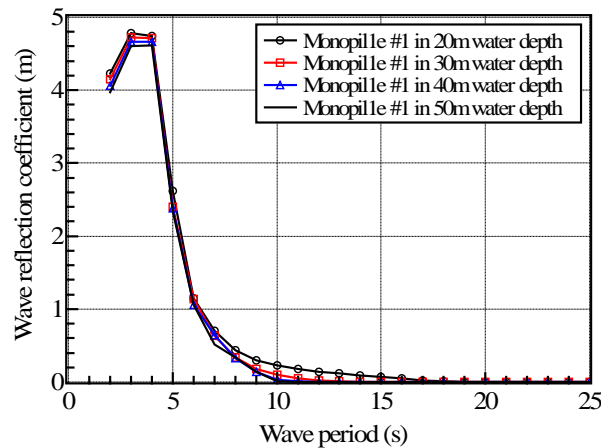

Figure 15 Wave reflection coefficients for monopile #1 in different water depths

Table 5 Wave reflection coefficients for monopile #2 in different water depths

Wave period (s)	Water depth (m)			
	20	30	40	50
2.0	8.299	8.198	8.097	7.996
3.0	8.422	8.240	8.188	8.013
4.0	8.860	8.824	8.774	8.723
5.0	9.623	9.661	9.629	9.599
6.0	7.111	7.026	7.054	7.042
7.0	4.250	4.357	4.307	4.140
8.0	3.322	2.789	2.643	2.619
9.0	2.329	1.811	1.620	1.564
10.0	1.734	1.273	1.064	0.976
11.0	1.356	0.953	0.749	0.638
12.0	1.100	0.751	0.553	0.426
13.0	0.921	0.611	0.418	0.283
14.0	0.789	0.506	0.317	0.172
15.0	0.687	0.421	0.230	0.069
16.0	0.604	0.346	0.146	0.036
17.0	0.532	0.275	0.057	0.004
18.0	0.469	0.203	0.004	0.001
19.0	0.409	0.126	0.001	0.001
20.0	0.349	0.042	0.001	0.001
21.0	0.290	0.003	0.001	0.001
22.0	0.229	0.001	0.001	0.001
23.0	0.163	0.001	0.001	0.001
24.0	0.093	0.001	0.001	0.001
25.0	0.019	0.001	0.001	0.001

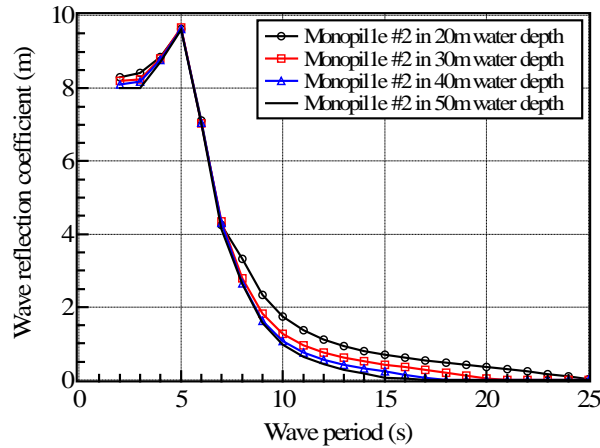

Figure 16 Wave reflection coefficients for monopile #2 in different water depths

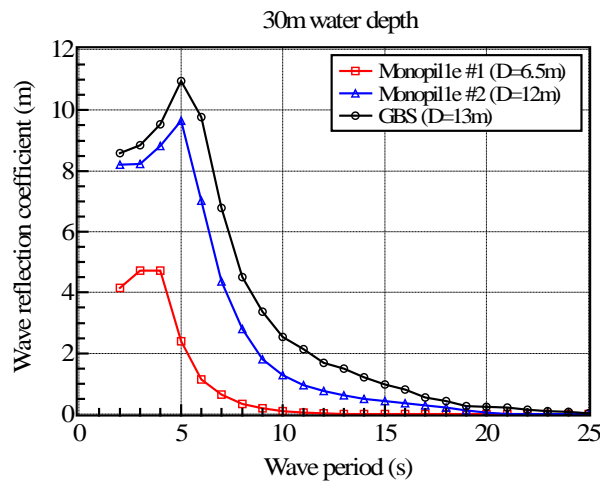

Figure. 17 Wave reflection coefficients for 3 foundations in water depth of 30m

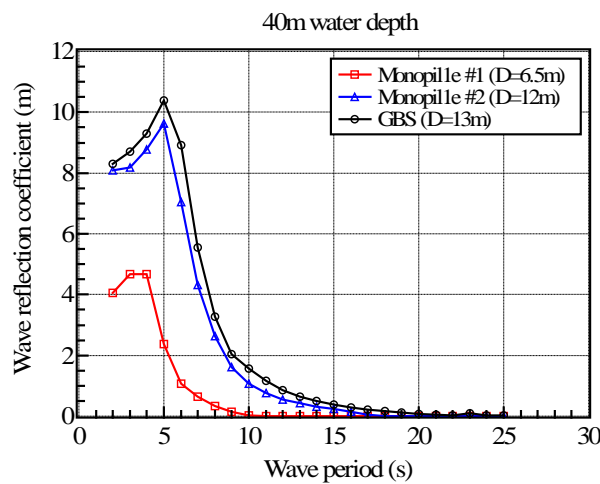

Figure 18 Wave reflection coefficients for 3 foundations in water depth of 40m

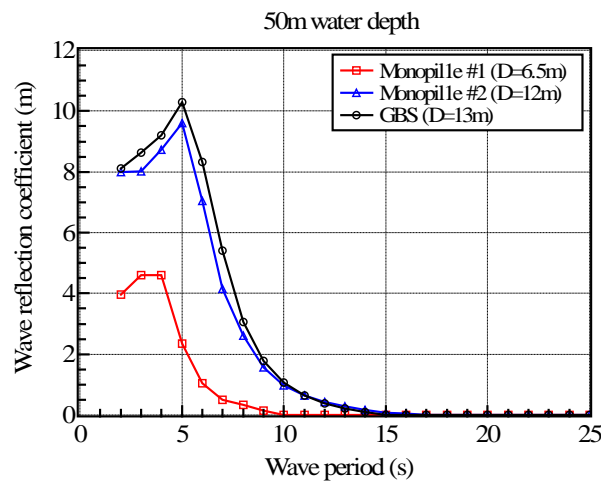

Figure 19 Wave reflection coefficients for 3 foundations in water depth of 50m

Concluding remarks

117. In the present report, wave reflection coefficients have been calculated to indicate the near-field effects of wind turbine foundations.
118. Three types/dimensions of wind turbine foundations (one GBS and two monopiles) for different water depths are considered and wave reflections coefficients are plotted under wave period ranging from 2 to 25 seconds.
119. Reasonable results are obtained, which indicate more energy is reflected in short waves and less reflection effects are found in long waves.
120. It can be seen that the peak wave reflection coefficients occur around 5s for GBS foundation and monopile #2, and around 3-4s for monopile #1.
121. Also for the same water depth, larger wave reflection coefficients are found from GBS foundation and monopile #2, and smaller wave reflection coefficients are obtained from monopile #1.

References

- Eatock Taylor, R. and Chau, F. P., 1992. Wave diffraction theory – some developments in linear and non-linear theory. Transactions of ASME, Journal of Offshore Mechanics and Arctic Engineering, 114, pp. 185-194.
- Sun, L., Choo, Y.S., Eatock Taylor, R., Llorente, C., 2012. Responses of floating bodies with flexible connections. In: Proceedings of the 2nd Marine Operations Specialty Symposium (MOSS 2012), pp. 229-243, Singapore.
- Sun, L., Eatock Taylor, R. and Choo, Y.S., 2011. Responses of interconnected floating bodies. The IES Journal Part A: Civil & Structural Engineering, 4(3), pp. 143-156.
- Sun L, Eatock Taylor R. and Taylor P. H., 2010. First- and second-order analysis of resonant waves between adjacent barges. Journal of Fluids and Structures, 26(6), pp. 954-978.
- Sun, L., Teng, B., Liu, C. F., 2008. Removing irregular frequencies by a partial discontinuous higher order boundary element method. Ocean Engineering, 35, pp. 920-930.
- Trulsen, K. and Teigen, P., 2002. Wave scattering around a vertical cylinder: fully nonlinear potential flow calculations compared with low order perturbation results and experiments. Proceedings of the 21st International Conference on Offshore Mechanics and Arctic Engineering (OMAE 2002), Oslo, Norway.
- Walker, D., Eatock Taylor, R., Taylor, P. and Zang, J., 2008. Wave diffraction and near-trapping by a multi-column gravity based structure. Ocean Engineering, 35 (2), pp. 201-229.
- Walker, D. A. G., Taylor, P. H., Eatock Taylor, R. and Zang, J., 2006. Diffraction theory as a tool for predicting airgap beneath a multicolumn gravity-based structure. International Journal of Offshore and Polar Engineering, 16 (3), pp. 175-182.
- Zang, J., Gibson, R., Taylor, P. H., Eatock Taylor, R. and Swan, C., 2006. Second order wave diffraction around a fixed ship-shaped body in unidirectional steep waves. Journal of Offshore Mechanics and Arctic Engineering, 128 (2), pp. 89-99.
- Zang, J., Liu, S., Eatock Taylor, R. and Taylor, P. H., 2009. Wave run-up and response spectrum for wave scattering from a cylinder. International Journal of Offshore and Polar Engineering, 19 (3), pp. 183-188.
- Zang, J., Taylor, P. H. and Eatock Taylor, R., 2005. Non-linear interaction of directionally spread waves with FPSO. In: 20th International Workshop on Water Wave and Floating Bodies, Spitsbergen, Norway.

Annex 3 – Set-up and verification of MIKE21 spectral wave model

Background

122. This Appendix describes the MIKE21 Spectral Wave model setup and verification for the proposed East Anglia TWO and proposed East Anglia ONE North projects. In addition to individual project modelling for each wind farm, the wave model has also considered the cumulative effects from both of these projects and the following other wind farm projects (built or planned):

- East Anglia ONE
- East Anglia THREE
- Norfolk Vanguard East
- Norfolk Vanguard West
- Norfolk Boreas
- Hornsea Project 1
- Hornsea Project 2
- Hornsea Project 3
- Greater Gabbard
- Galloper

123. The MIKE21-SW wave model has been run to assess the following conditions:
- Baseline conditions;
 - Impacts on baseline conditions individually by the proposed East Anglia ONE North project;
 - Impacts on baseline conditions individually by the proposed East Anglia TWO project;
 - Impacts on baseline conditions cumulatively by all relevant projects
124. Due to the vast size of the study area, the MIKE21-SW wave model was split into two model areas, the main model (red outline) and an auxiliary model (blue outline), shown on Figure 1.

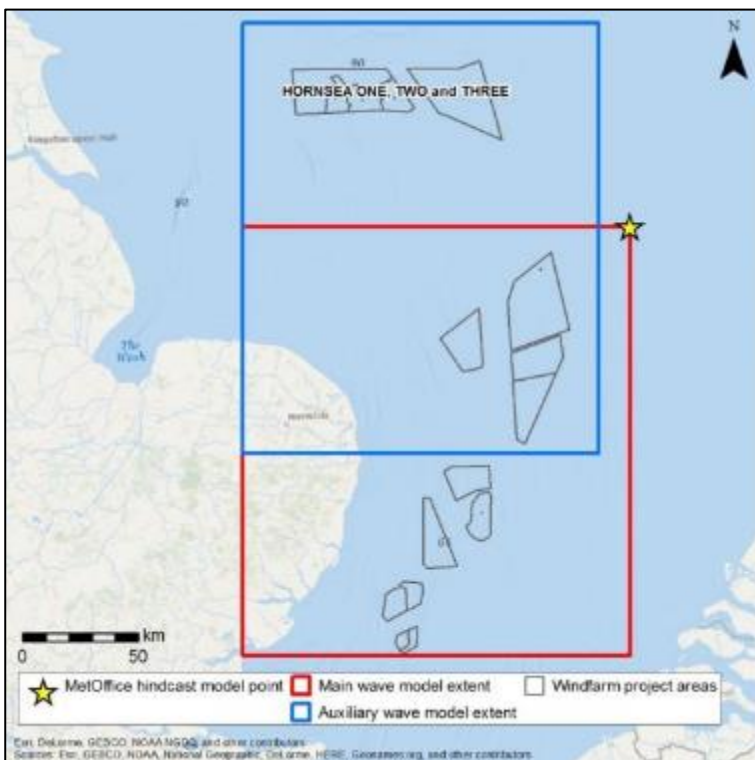

Figure 1: Main and Auxiliary Wave Model extents

125. The auxiliary model was used to assess whether the Hornsea Project 1, Hornsea Project 2 and Hornsea Project 3 wind farm projects have an impact on the former East Anglia Zone, located further to the south. **Figure 1** shows the three projects within the Hornsea Zone.
126. If no significant impacts were identified from these three projects cumulatively on the former East Anglia Zone, then the main model alone could be used to assess cumulative effects from the other projects (**Figure 2**). The purpose of splitting the assessment in

Table 1 Comparison of MIKE21-SW and SWAN functionality

Function	MIKE 21-SW	SWAN
Brief Description	State-of-the-art third generation spectral wind-wave model that simulates the growth, decay and transformation of wind-generated waves and swells in offshore and coastal areas.	State-of-the-art third generation spectral wind-wave model that simulates the random, short-crested wind-generated waves in coastal areas and inland waters.
Developer	Danish Hydraulic Institute (DHI)	Delft University of Technology (DUT)
Computational Mesh	Flexible mesh	Regular or flexible mesh (curvilinear or triangular)
Wave growth by action of wind	Yes	Yes
Non-linear wave-wave interaction	Yes	Yes
Dissipation due to white-capping	Yes	Yes
Dissipation due to bottom friction	Yes	Yes
Dissipation due to depth-induced wave breaking	Yes	Yes
Refraction due to depth variations	Yes	Yes
Shoaling due to depth variations	Yes	Yes
Wave-current interaction	Yes	Yes
Wave reflection	Yes, an array of reflection/transmission coefficients can be defined for various wave heights, periods and water depths which provides a facility to take on output from the CFD model (DIFFRACT) simulation of reflection/transmission around foundations at a local scale	Yes, but it is defined by a single constant coefficient
Wave diffraction	Yes, but approximate and not well suited for structure scale diffraction (focused on diffraction due to headlands)	Yes, but approximate and not well suited for structure scale diffraction (focused on diffraction due to headlands)
Effect of time-varying water depth	Yes	Yes
Effect of ice coverage on wave field	Yes (but not relevant in this case)	No (but not relevant in this case)

Function	MIKE 21-SW	SWAN
Software status	Industry standard	Industry standard

129. **Figure 3** and **Figure 4** show the wave model extent and bathymetry for the main and auxiliary wave model retrospectively. The bathymetry mesh was generated by using C-Map data. The resolution of the model mesh is 200m inside wind farm project areas and 700m outside the project areas, shown in **Figure 5**. This resolution is important for the impact model runs, because it ensures that there are at least four to five mesh cells between each wind turbine foundation.

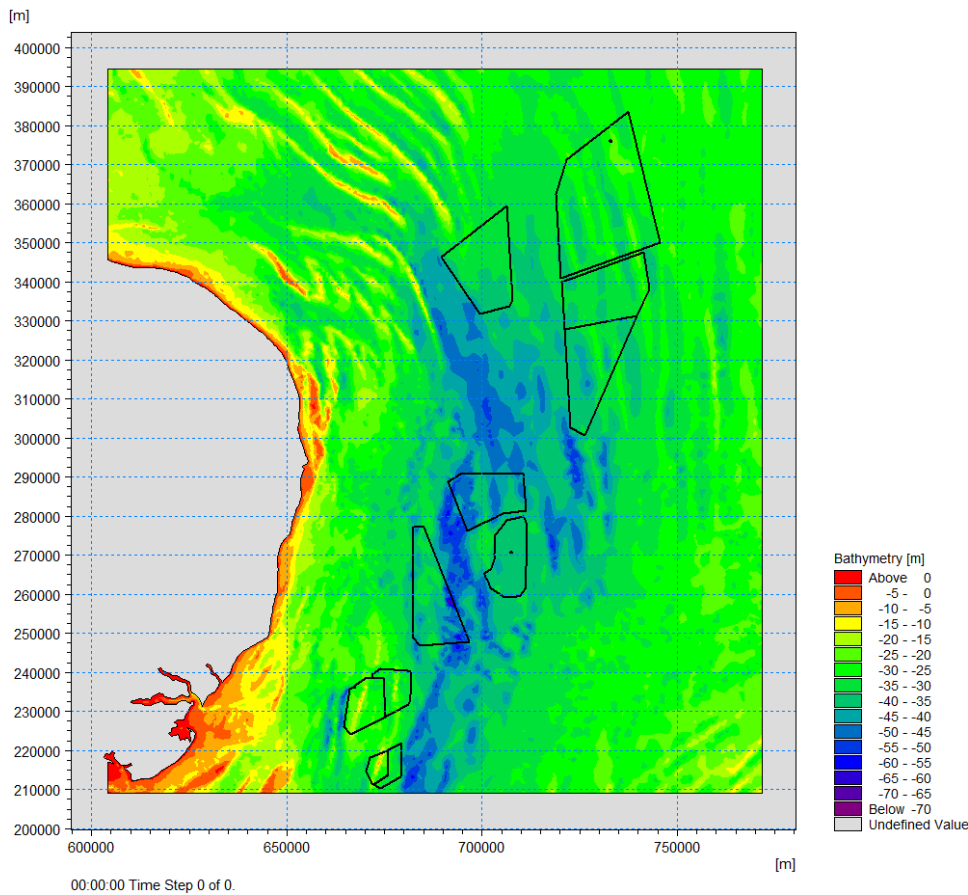

Figure 3: Main wave model extent and bathymetry

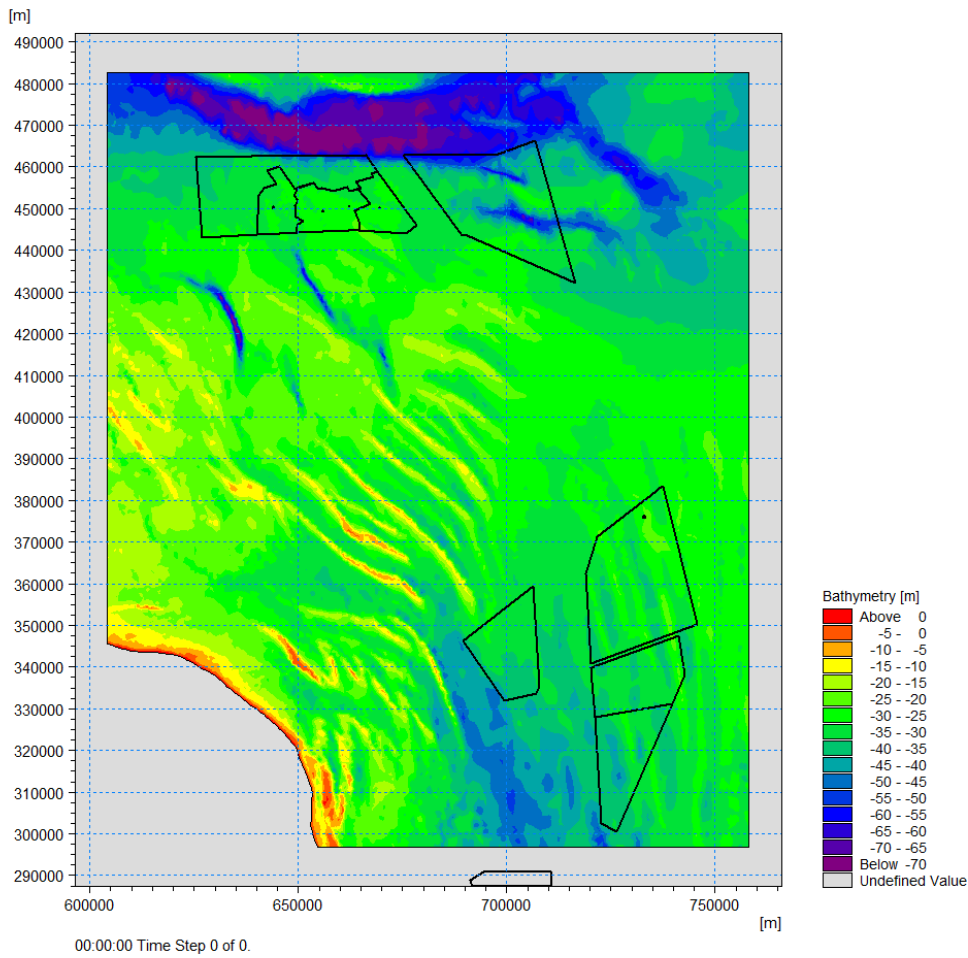

Figure 4: Auxiliary wave model extent and bathymetry

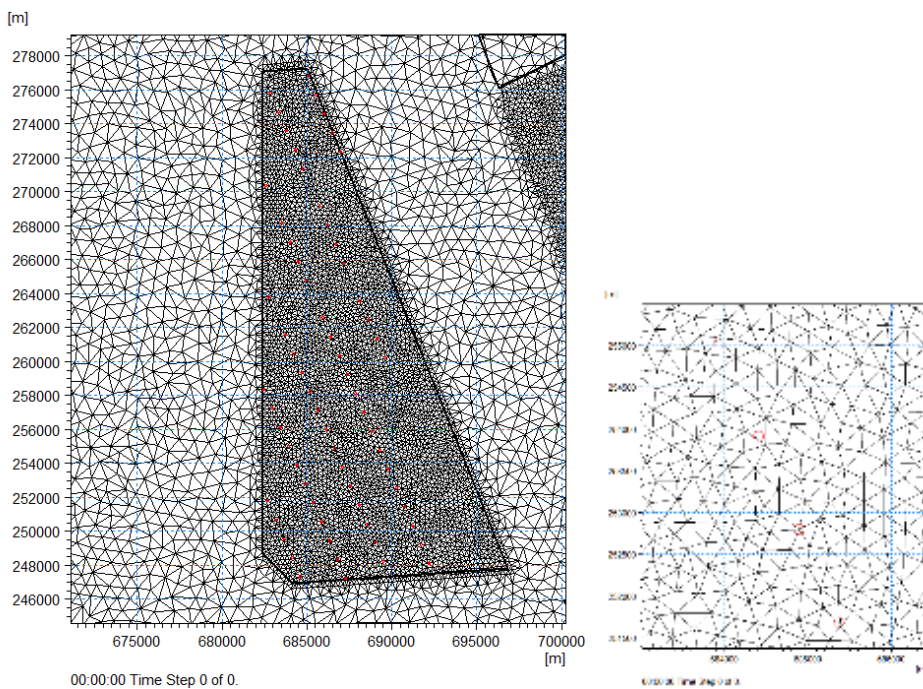

Figure 5: Model mesh resolution (example zoom-in on East Anglia TWO project) with 60m foundations (red circles)

130. For the ‘with scheme’ model runs, the foundations of the wind farm turbines, met masts and offshore platforms were represented using the wave reflection coefficients derived from the local scale DIFFRACT modelling (see Appendix B for further details). The MIKE21-SW model is able to represent the foundations using these coefficients at a sub-grid scale.

Model Verification

131. The main wave model was verified by comparing the model results with measured wave data at three wave buoy locations shown in Figure 6. Wave data was available at locations DWR C, E and F for the period between December 2012 and August 2013. Wave buoy DWR C is closest to the proposed East Anglia TWO and proposed East Anglia ONE North project sites. **Figure 7** to **Figure 9** show the wave roses for the data collected from these three wave buoys.
132. For the model verification, five wave events lasting two to four days were picked from the measured wave data, representing the most relevant wave direction sectors for cumulative assessments, namely North, North-North-East and East. The wave model is driven by the Met Office hindcast data (as described in Appendix A), the location of which is also shown in **Figure 6**. The time-series water level used to run the wave model was measured at the Lowestoft tide gauge shown in **Figure 6**.
133. For the purpose of this study, only the main wave model was verified. The auxiliary model has not separately been verified but is expected to be similarly accurate since it is driven by the same underlying computations.
134. The Met Office hindcast data from the model point has been applied all the way around the model boundary. In reality, the boundary conditions would not be universal, but there is no measured offshore wave data available that is close to the model boundary.

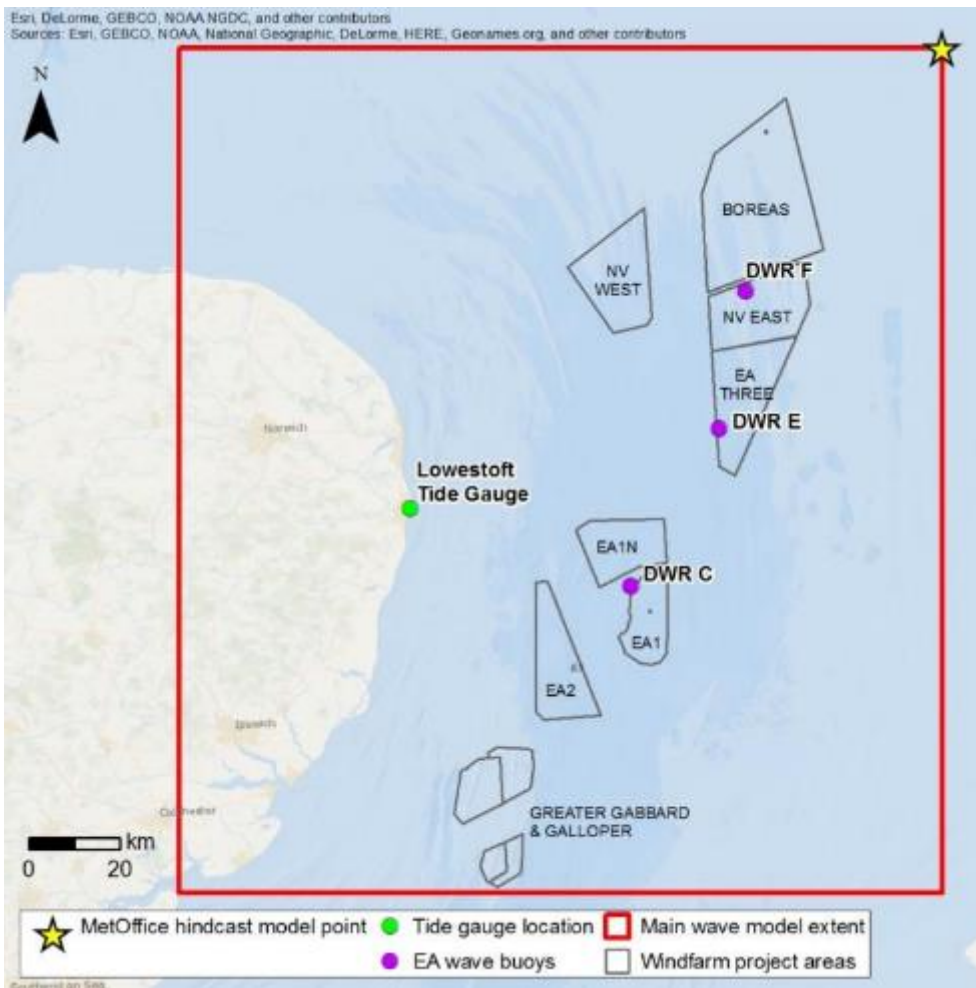

Figure 6: Wave buoy, Tide gauge and Met Office hindcast model point locations

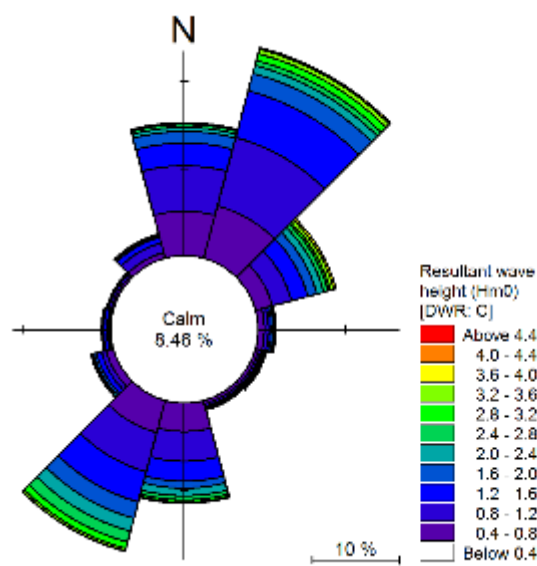

Figure 7: Wave rose for buoy DWR C

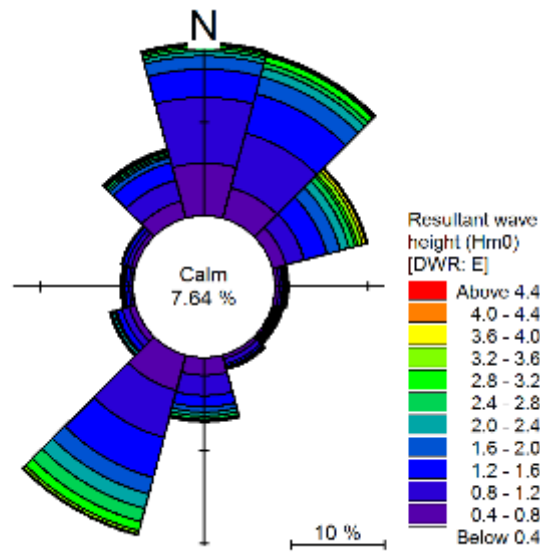

Figure 8: Wave rose for buoy DWR E

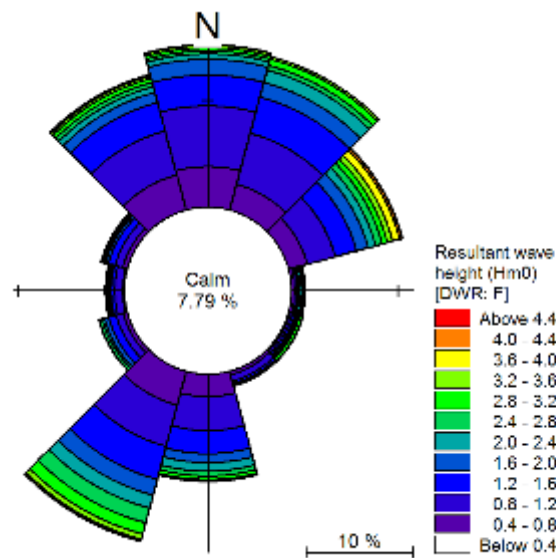
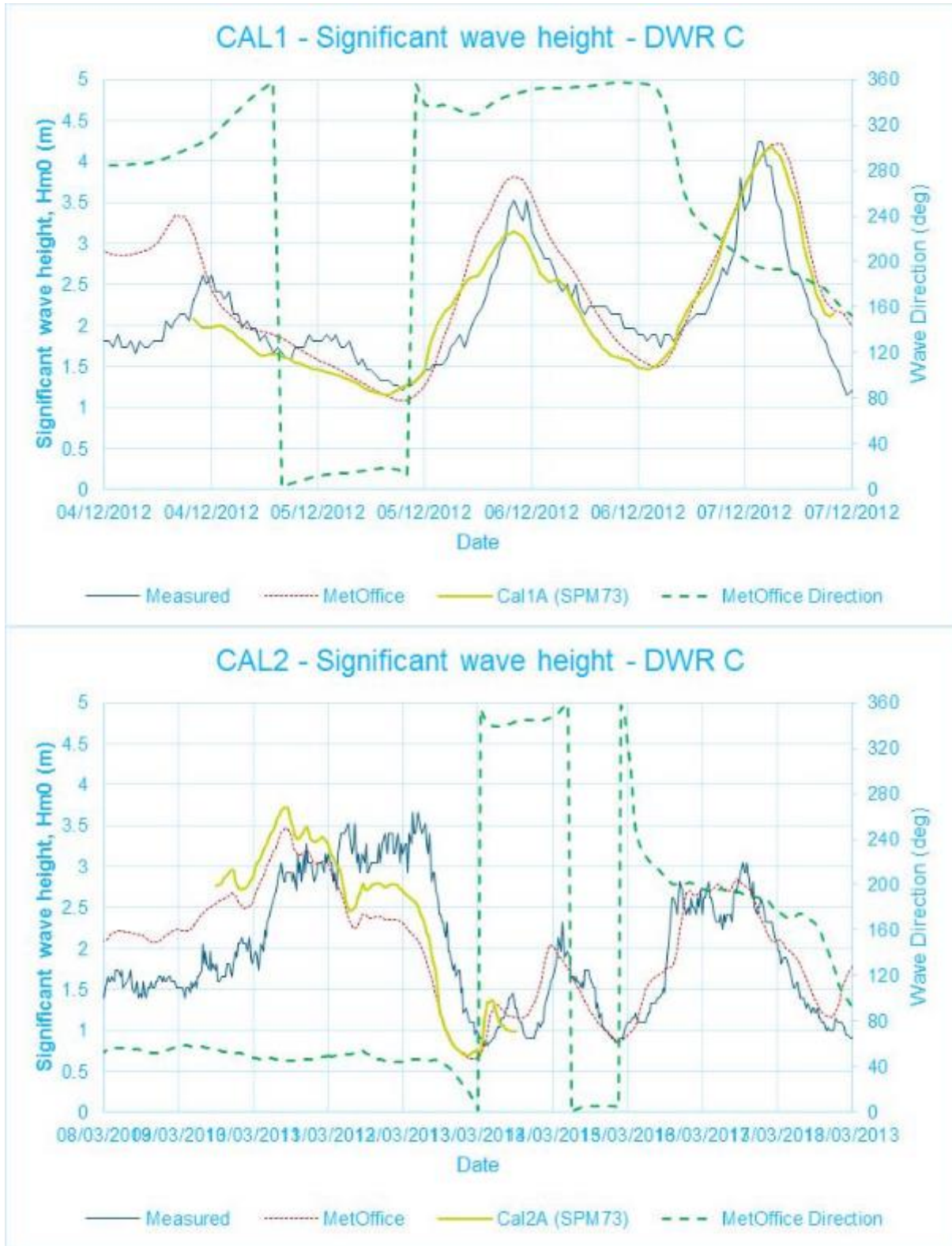
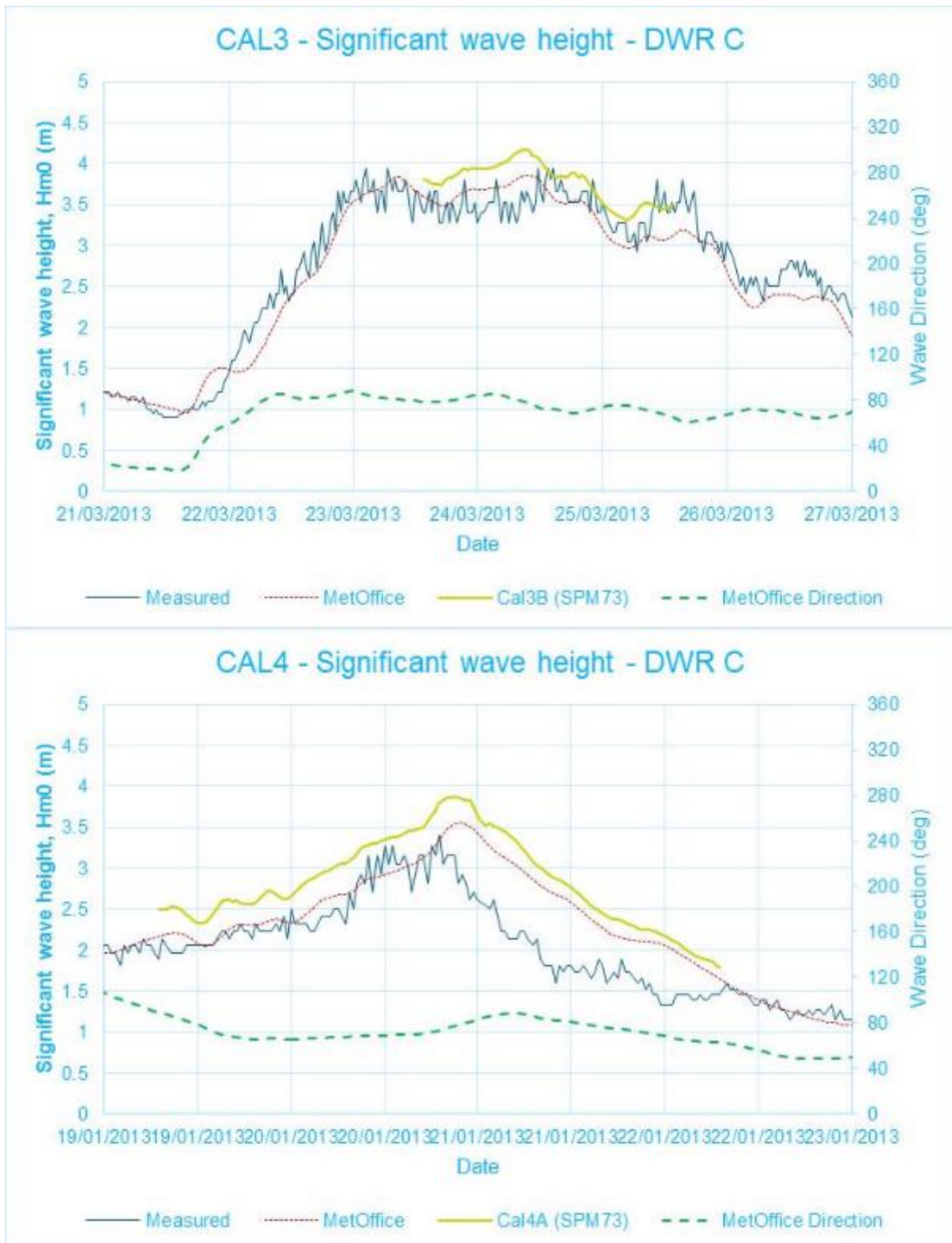

Figure 9: Wave rose for buoy DWR F

135. **Figure 10** to **Figure 12** show the output from the MIKE21-SW model verification undertaken at each of the three locations where wave buoy measurements were available (i.e. DWR C, DWR E and DWR F) and for each of the six verification events used (these are named CAL1 to CAL6 in the figures). The outputs of the validation exercise demonstrate exceptionally good outputs when compared against the measured data and demonstrate the MIKE21-SW model to be suitable for its intended purpose.

Figure 10 – Verification Plots for Wave Buoy DWR C under six verification events (CAL1 to CAL6)





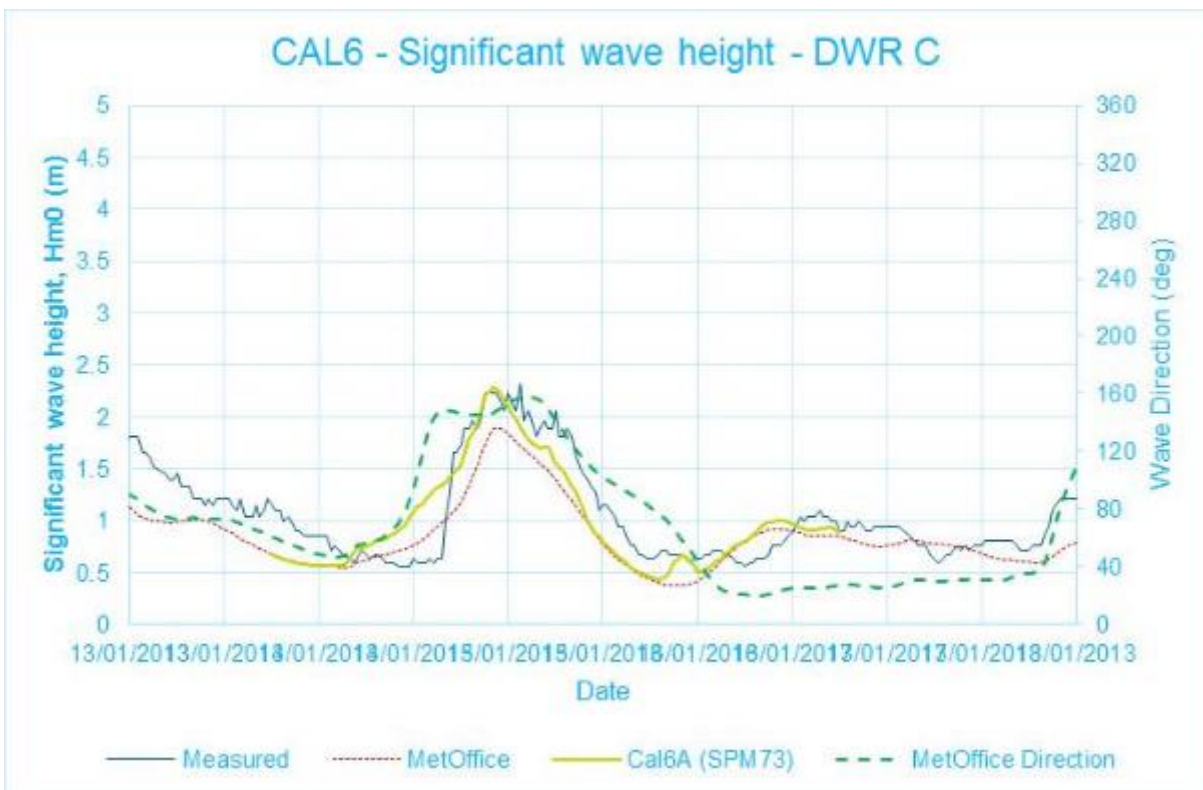
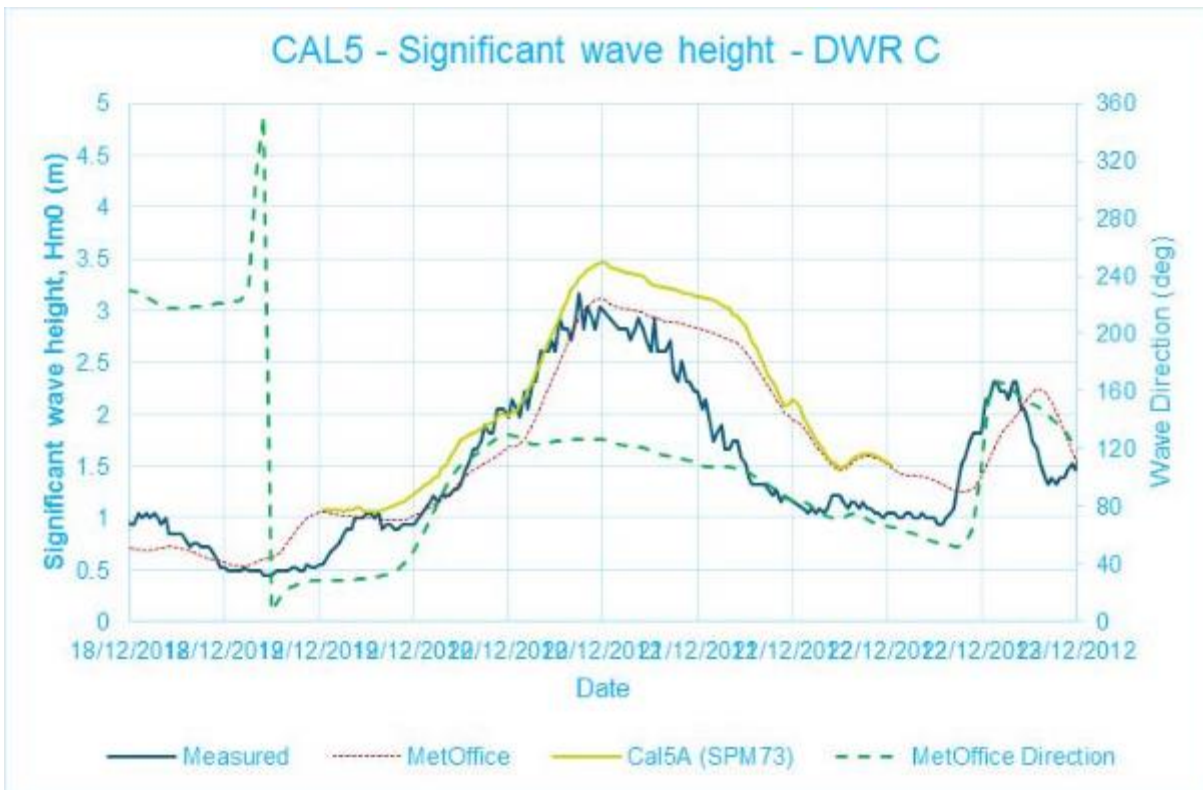
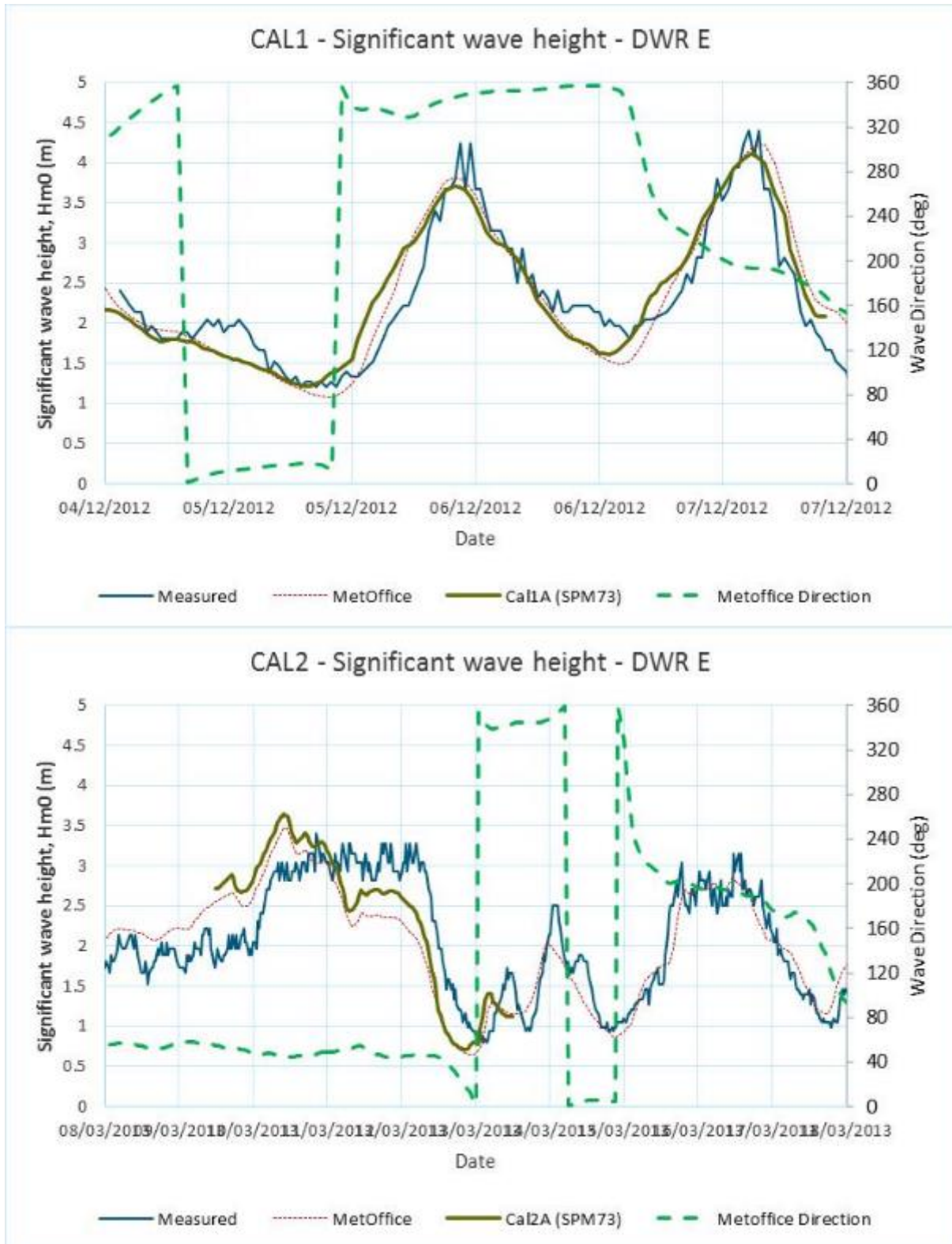
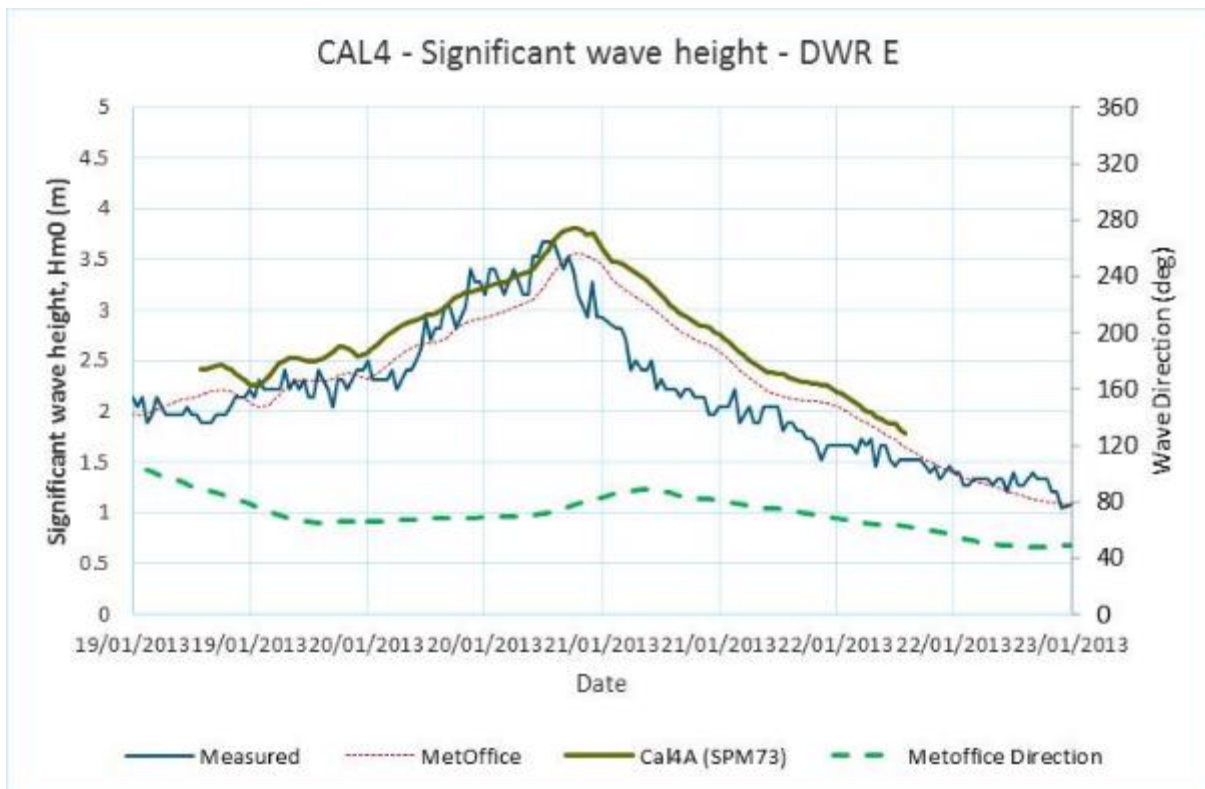
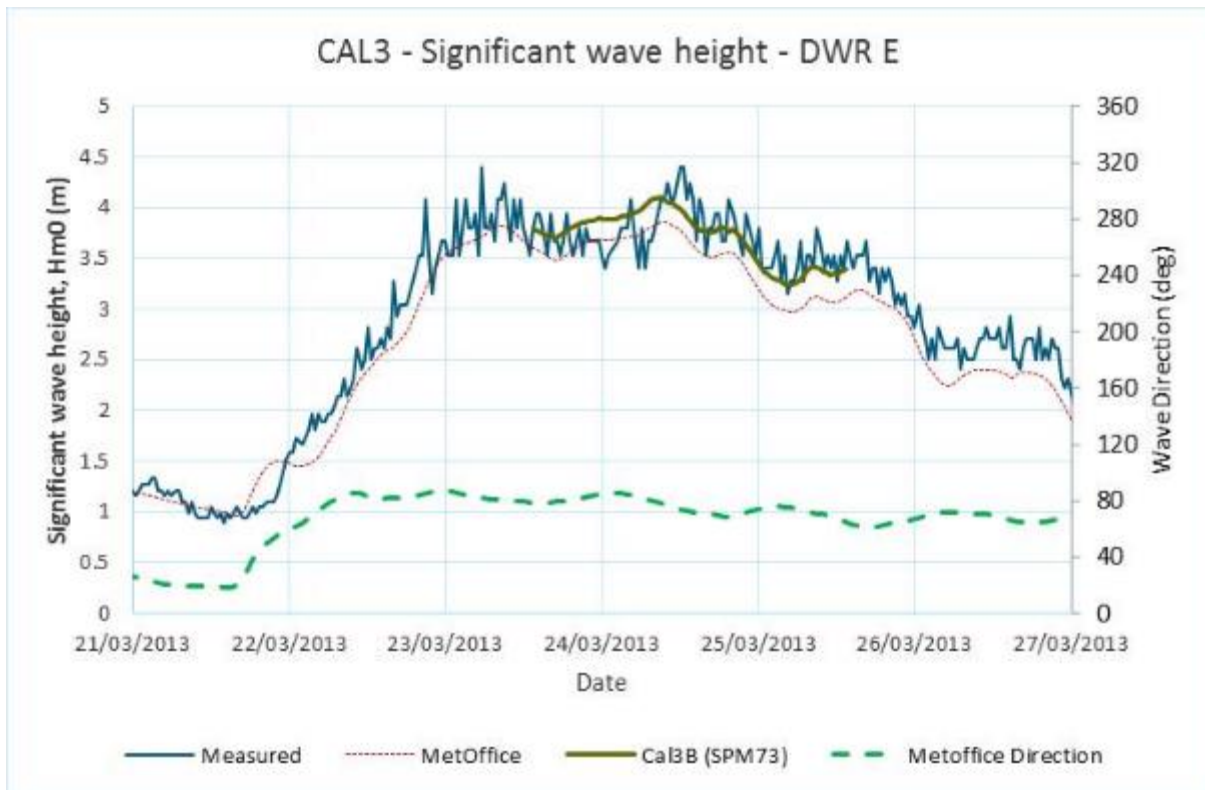

Figure 11 – Verification Plots for Wave Buoy DWR E under six verification events





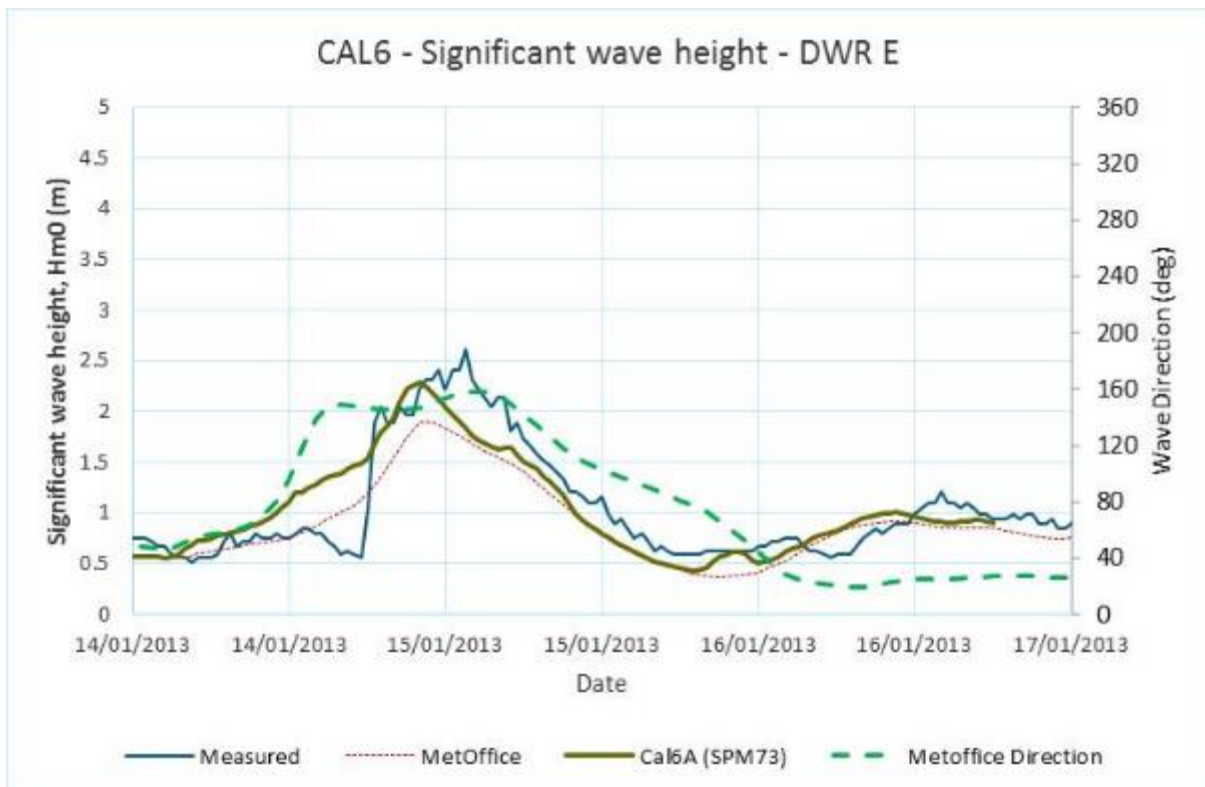
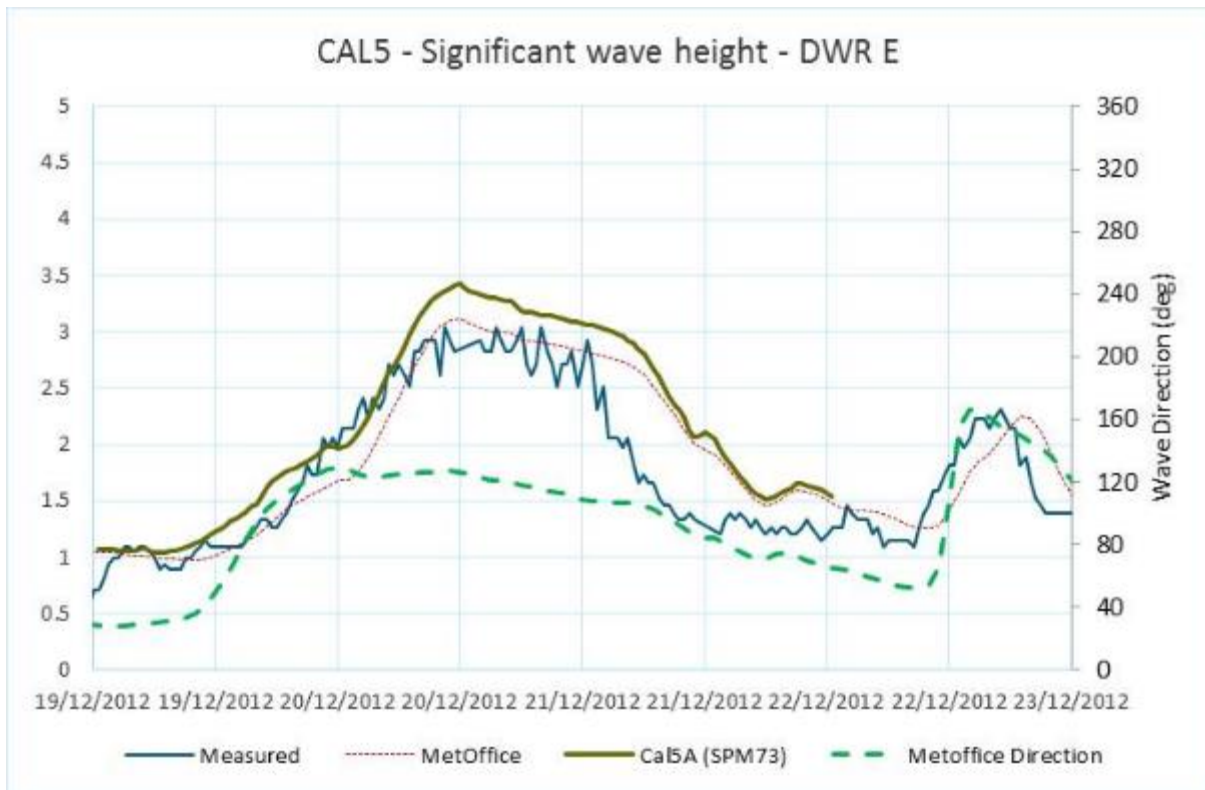
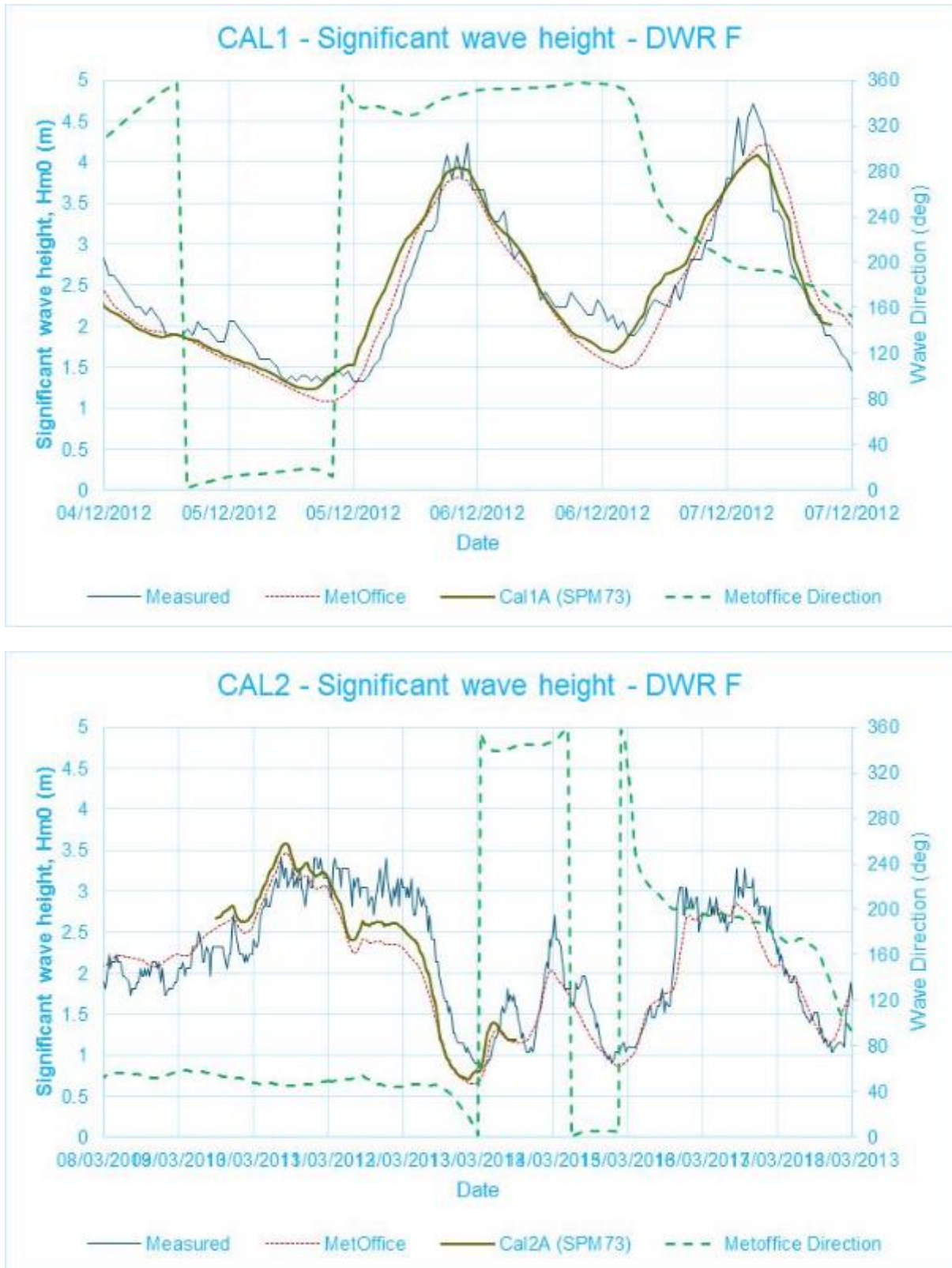
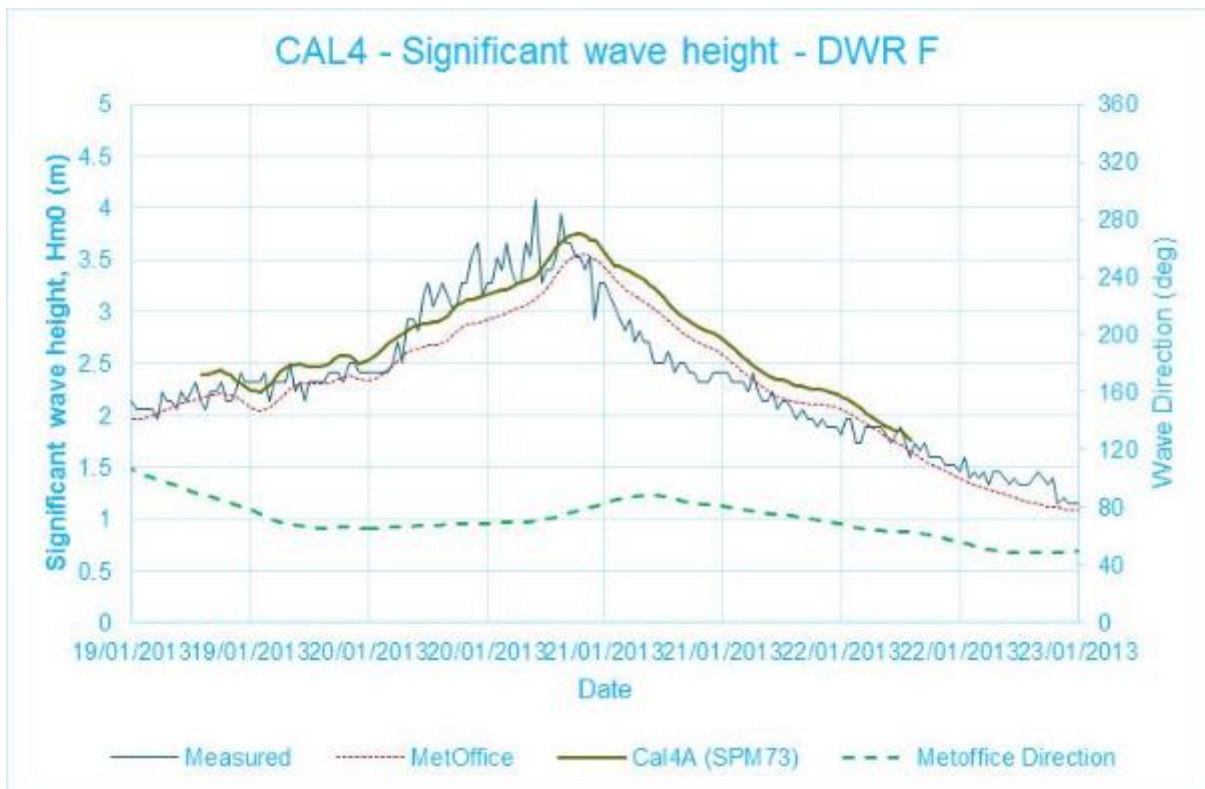
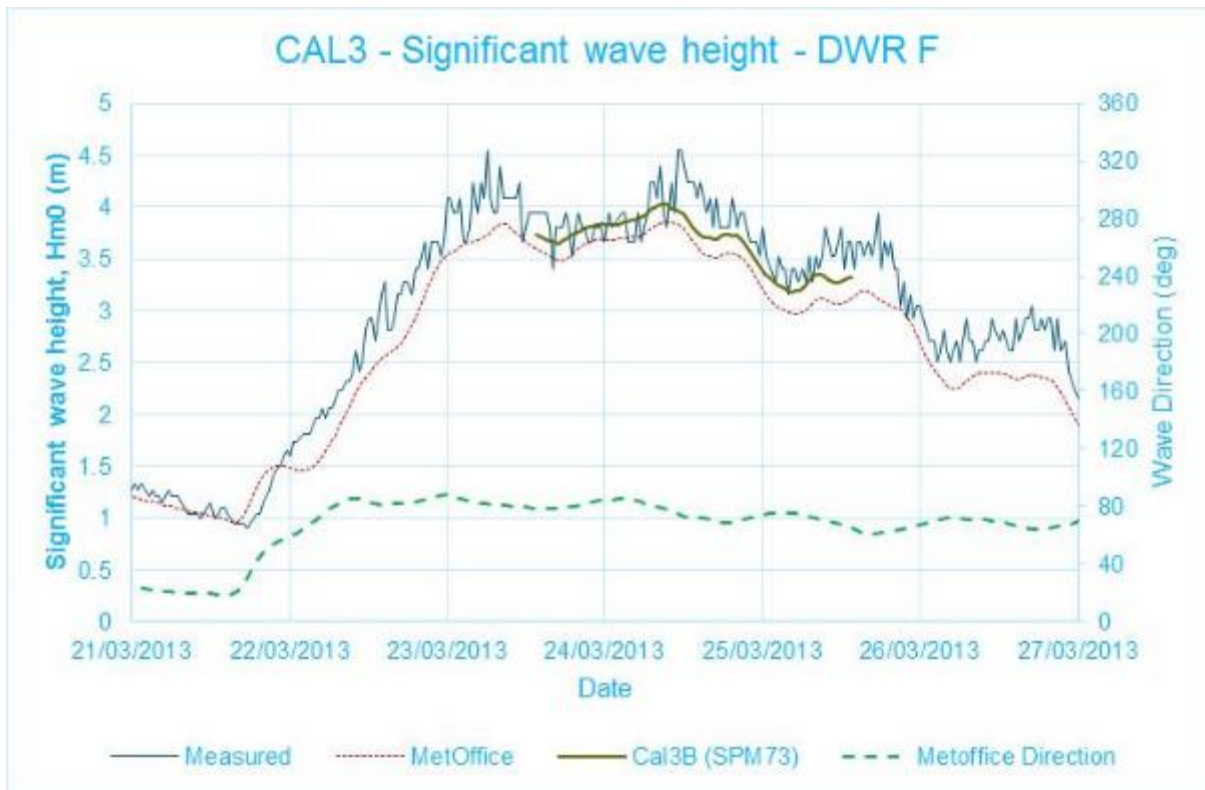
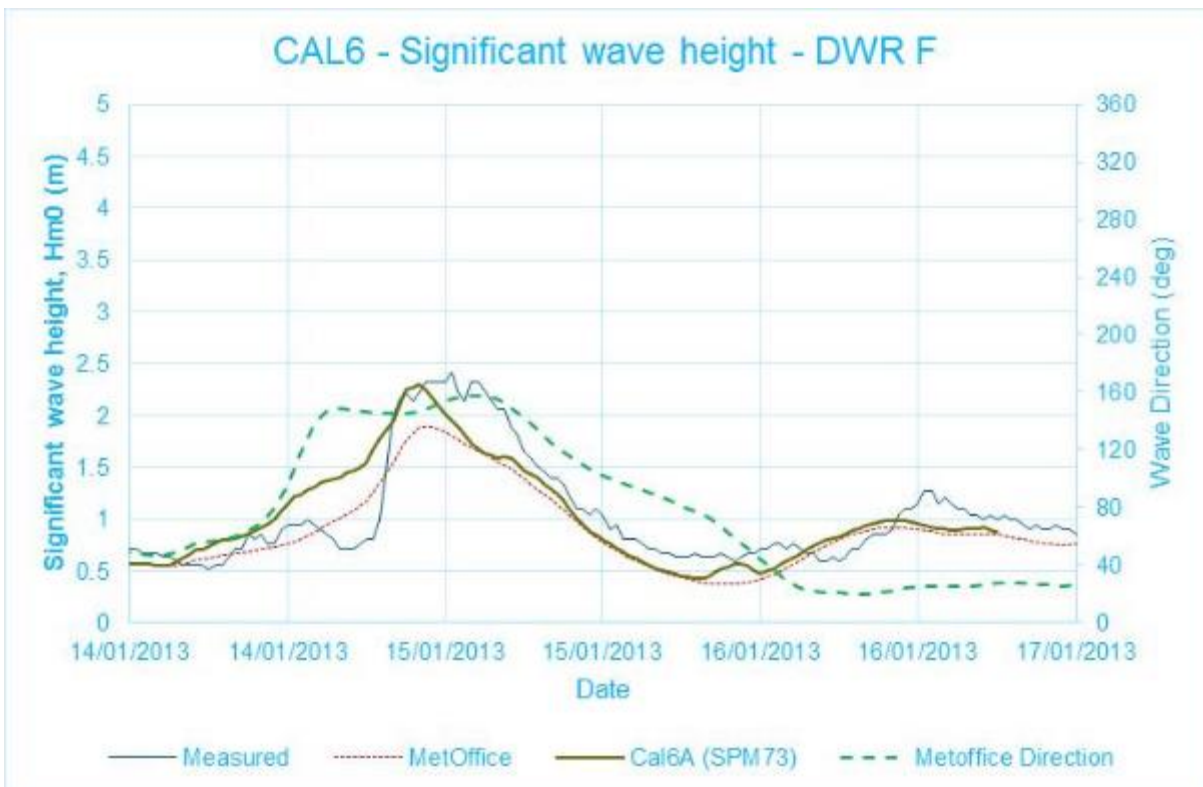
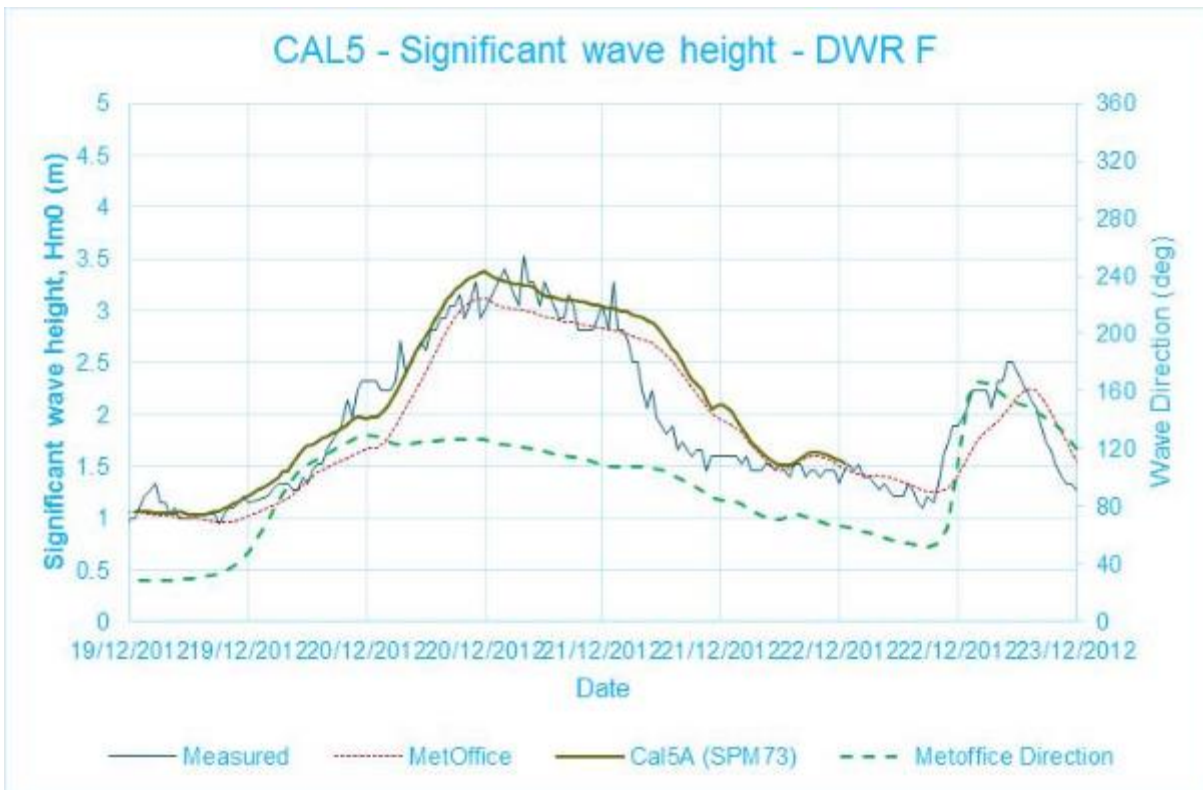

Figure 12 – Verification Plots for Wave Buoy DWR F under six verification events







136. Once verified, the main and auxiliary wave models were run based on the results of the wave extremes analysis described in Appendix A. The largest significant wave height that occurs in the Met Office hindcast data is 4.8m, but the extremes analysis for the 1 in 50 year return period shows the significant wave height to be 5.8m. This is why it was necessary to establish the relationship between the significant wave height (Hs) and Wave period (Tp), using a logarithmic trendline and, using this equation, to calculate the corresponding Tp to those higher wave heights. The same method was used to establish the relationship between the significant wave height (Hs) and wind speed using a linear formula. These relationships are shown in **Figure 13** and **Figure 14**.

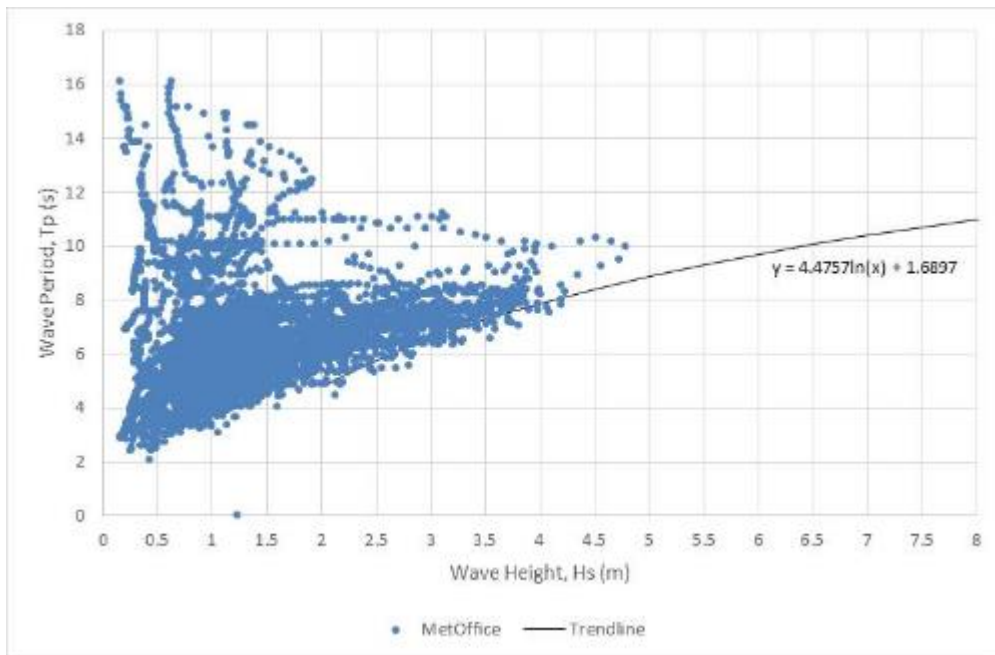

Figure 13: Relationship between Significant Wave Height (Hs) and Peak Wave Period (Tp)

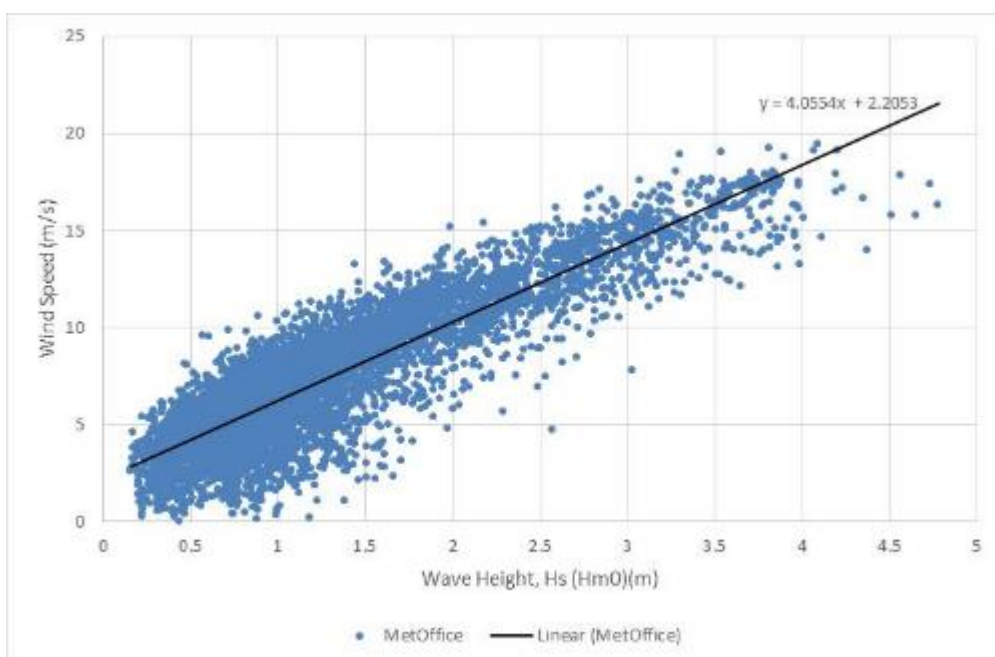

Figure 14: Relationship between Significant Wave Height (Hs) and Wind Speed

Auxiliary Wave Model Runs

137. The auxiliary wave model was run for two return periods, 1 in 1 year and 1 in 50 year. The wave directions that would have the most impact on the wind farm projects located to the south of Hornsea are waves from north and north-east. For this reason, the model has been run for those two wave directions. **Table 2** shows the input parameters for the auxiliary model.

Table 2: Auxiliary wave model input parameters

Return Period	Water Level (MSL)	Hs (m)	Tp (s)	Waves from	Wave Dir (deg)	Wave Spread (deg)	Wind Speed (m/s)	Wind Dir (deg)
1 in 1	1.66	4.77	8.68	N	0	30	21.55	0
1 in 50	1.66	7.59	10.76	N	0	30	32.99	0
1 in 1	1.66	3.62	7.45	NNE	30	30	16.89	30
1 in 50	1.66	5.84	9.59	NNE	30	30	25.89	30

138. In addition, runs were made with the water level elevated by 1 m as a form of sensitivity test. The input parameters for these runs are shown in **Table 3**.

Table 3: Auxiliary wave model input parameters for water level sensitivity runs

Return Period	Water Level (MSL)	Hs (m)	Tp (s)	Waves from	Wave Dir (deg)	Wave Spread (deg)	Wind Speed (m/s)	Wind Dir (deg)
1 in 1	2.66	4.77	8.68	N	0	30	21.55	0
1 in 50	2.66	7.59	10.76	N	0	30	32.99	0

139. The input parameters shown in **Table 2** and **Table 3** were used initially for baseline runs (i.e. without the wind farm structures) and then for ‘with scheme’ runs for the cumulative assessments. The results of the ‘with scheme’ runs were compared against the results from the baseline runs and the differences in significant wave height (in metres and as percentage changes) were calculated. This concluded that there is no significant cumulative effect arising from the Hornsea projects upon the area formerly known as the East Anglia Zone. The main test results are presented and discussed in the ES chapter. The results of the sensitivity tests with increased water levels demonstrated that the model is not significantly sensitive to water level.

Main Wave Model Runs

140. The main wave model has been run for two return periods, 1 in 1 year and 1 in 50 years and for waves from north (N), north-northeast (NNE) and east (E). These approach directions are relevant for potential cumulative effects on the nearest adjacent offshore wind farms and the nearest identified receptors, including the nearest section of the UK coastline, which lies in an easterly direction. **Table 4** shows the input parameters for the main wave model.

Table 4: Main wave model input parameters

Return Period	Water Level (MSL)	Hs (m)	Tp (s)	Waves from	Wave Dir (deg)	Wave Spread (deg)	Wind Speed (m/s)	Wind Dir (deg)
1 in 1	1.66	4.77	8.68	N	0	30	21.55	0
1 in 50	1.66	7.59	10.76	N	0	30	32.99	0
1 in 1	1.66	3.62	7.45	NNE	30	30	16.89	30
1 in 50	1.66	5.84	9.59	NNE	30	30	25.89	30
1 in 1	1.66	3.04	6.67	E	95	30	14.53	95
1 in 50	1.66	4.14	8.05	E	95	30	18.99	95

141. The input parameters shown in Table 4 were used initially for baseline runs (i.e. without the wind farm structures) and then for 'with scheme' runs for both the individual project assessments (for the proposed East Anglia TWO and proposed East Anglia One North project) and the cumulative assessments (excluding the Hornsea projects). The results of the 'with scheme' runs (either individually or cumulatively) were compared against the results from the baseline runs and the differences in significant wave height (in metres and as percentage changes) were calculated. These results are presented and discussed in the ES chapter.

Annex 4 – Response to Discussion

Comments from Cefas on Presentation of Wave Model Results

Background

142. This Appendix provides a response to discussion comments from Cefas on the presentation of wave modelling results at the East Anglia TWO and East Anglia ONE North Benthic Ecology Expert Topic Group meeting on 21st March 2018 in London.
143. At this meeting, broader discussion also occurred with the MMO, Cefas and Natural England on the need, or otherwise, to further consider transboundary effects in the context of physical process and benthic ecology. This appendix also covers this matter.

Waves from the Southeast

144. Having seen the East Anglia ONE North and East Anglia TWO wave modelling results, Cefas enquired why waves from the SE had not also been modelled along with waves from N, NNE and E. There are two principal reasons.
145. Firstly, waves from the SE are relatively small in magnitude and infrequent in occurrence compared to waves from the N, NNE and, to a lesser extent, due E, as shown by **Figure 1**.

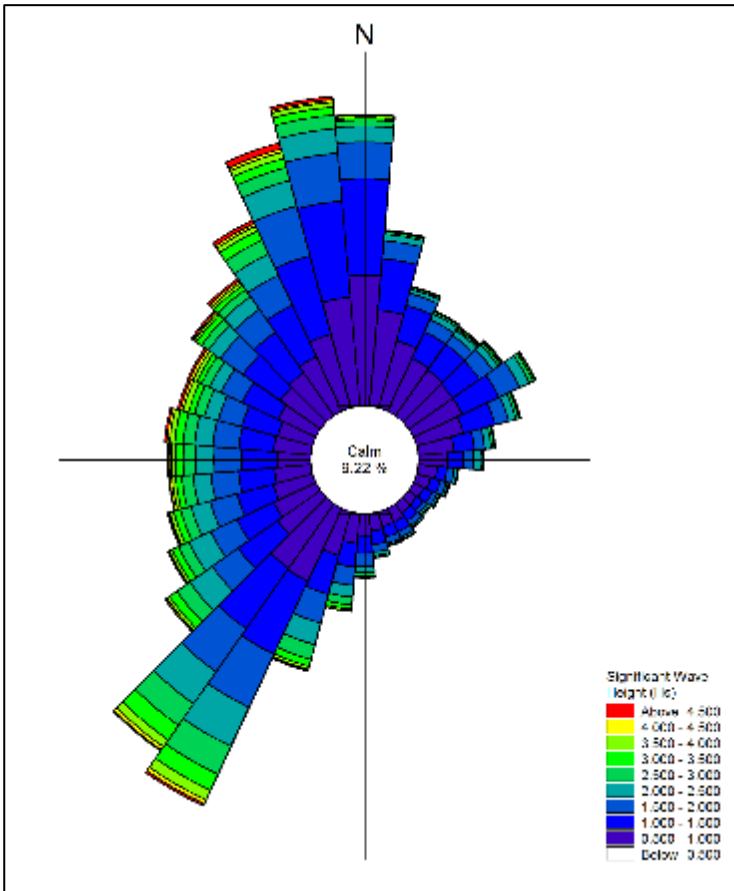

Figure 1: Offshore wave rose

146. Secondly, there is far less potential for cumulative effects to arise under offshore waves from the SE, compared to the other three wave approach directions which were modelled. This is shown by **Figure 2** which confirms that whilst there may be potential cumulative interactions between East Anglia ONE and part of East Anglia ONE North under a SE approach, there is far greater potential for multiple project interactions from other approach directions. It should be noted, that proposed methodology for undertaking wave modelling, including modelled wave directions were previously agreed with Cefas in October 2017, via a meeting on the 10th of October and the submission of a Method Statement.

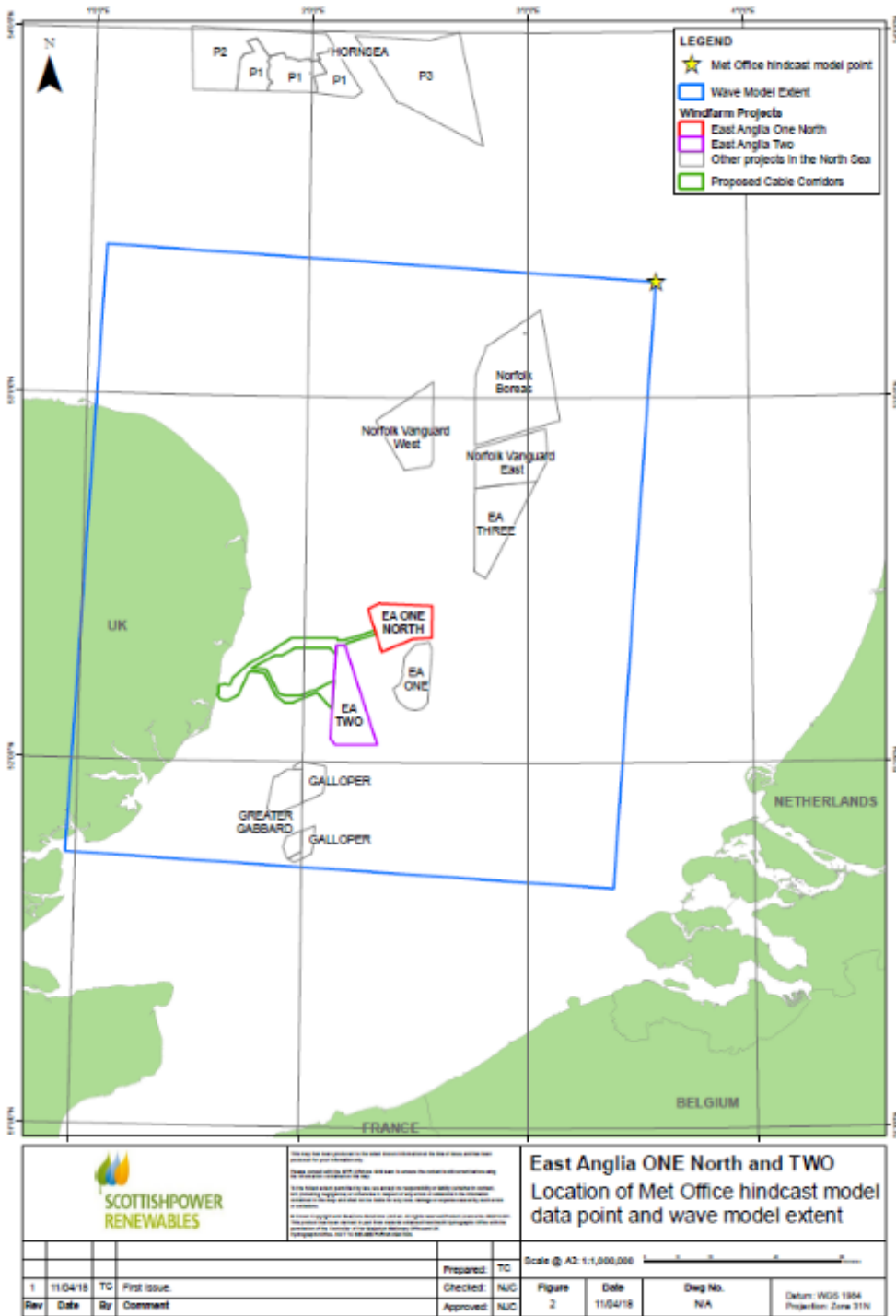

Figure 2: Windfarm project locations

Threshold for Wave Effects

147. It was pre-agreed with Cefas (via agreement of the Method Statement, October 2017) that a change in baseline wave conditions of $\pm 5\%$ was deemed a suitable threshold for meaningful change, with values less than this being deemed within the limits of modelling and measurement.
148. Upon viewing the wave modelling results, Cefas requested that reference was made to the Coastal Impact Study¹ guidance available to the marine aggregate dredging industry. That document uses a threshold of $\pm 3\%$. Even with this threshold, there were no far field changes arising from the modelling which exceeded this threshold in areas of sensitive sea bed or shoreline receptors.

Zone of Influence of Wave Effects

149. To improve clarity of the interpretation, Cefas requested that an appropriate zone of influence be established for the worst case wave effects and this be superimposed on a map of the sensitive sea bed and shoreline receptors.
150. The greatest effects, in terms of percentage change in baseline significant wave heights, were undoubtedly associated with the cumulative modelling assessments (rather than the individual project modelling) and with the 1 in 1 year return period event (compared to the 1 in 50 year return period event). Furthermore, the greatest potential cumulative effect on the identified sea bed and shoreline receptors along the East Anglian coast was associated with waves from E, due to their alignment with respect to the specific windfarm projects.
151. **Figure 3** shows the zone of influence map that was requested for this worst case condition. It can be seen that the magnitude of change in baseline conditions at the location of sensitive receptors was always $< 2\%$. Note that wave reflection effects would extend seaward of the eastern model boundary, but dissipate to baseline values well before reaching any identified receptors.

¹ The Crown Estate (2013) Marine Aggregate Dredging and the Coastline: a guidance note. Best practice guidance for assessment, evaluation and monitoring of possible effects of marine aggregate extraction on the coast- a Coastal Impact Study.

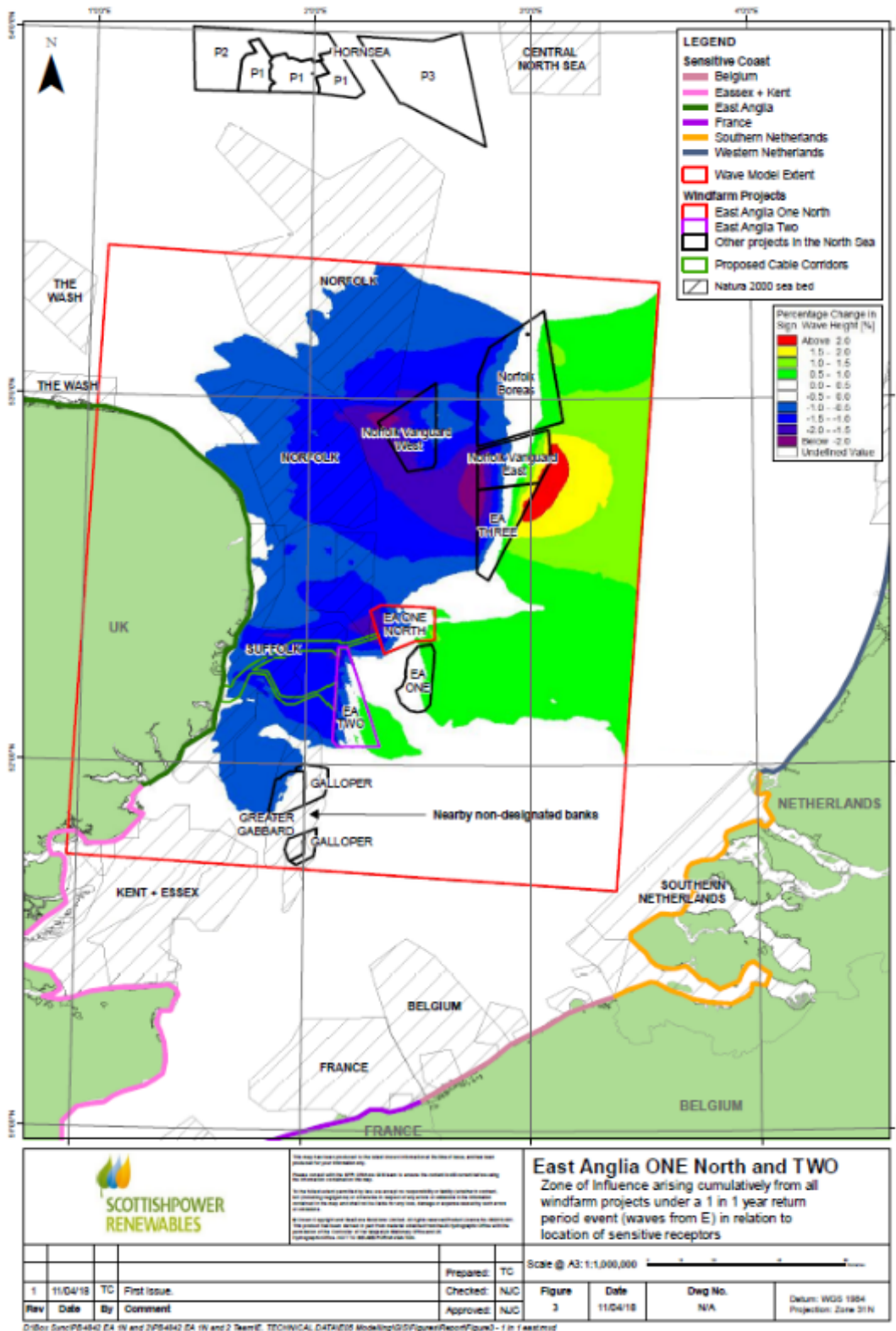

Figure 3: Worst case zone of influence for wave effects on sensitive receptors

Transboundary Effects

152. To investigate the potential for transboundary effects in the context of physical processes, consideration has been given to potential effects on each of the wave, tidal and sediment regimes. The receptors that could potentially be affected by transboundary effects are areas of the sea bed and shoreline in Belgium, France and Germany and part of the sea bed in the central North Sea (**Figure 4**).

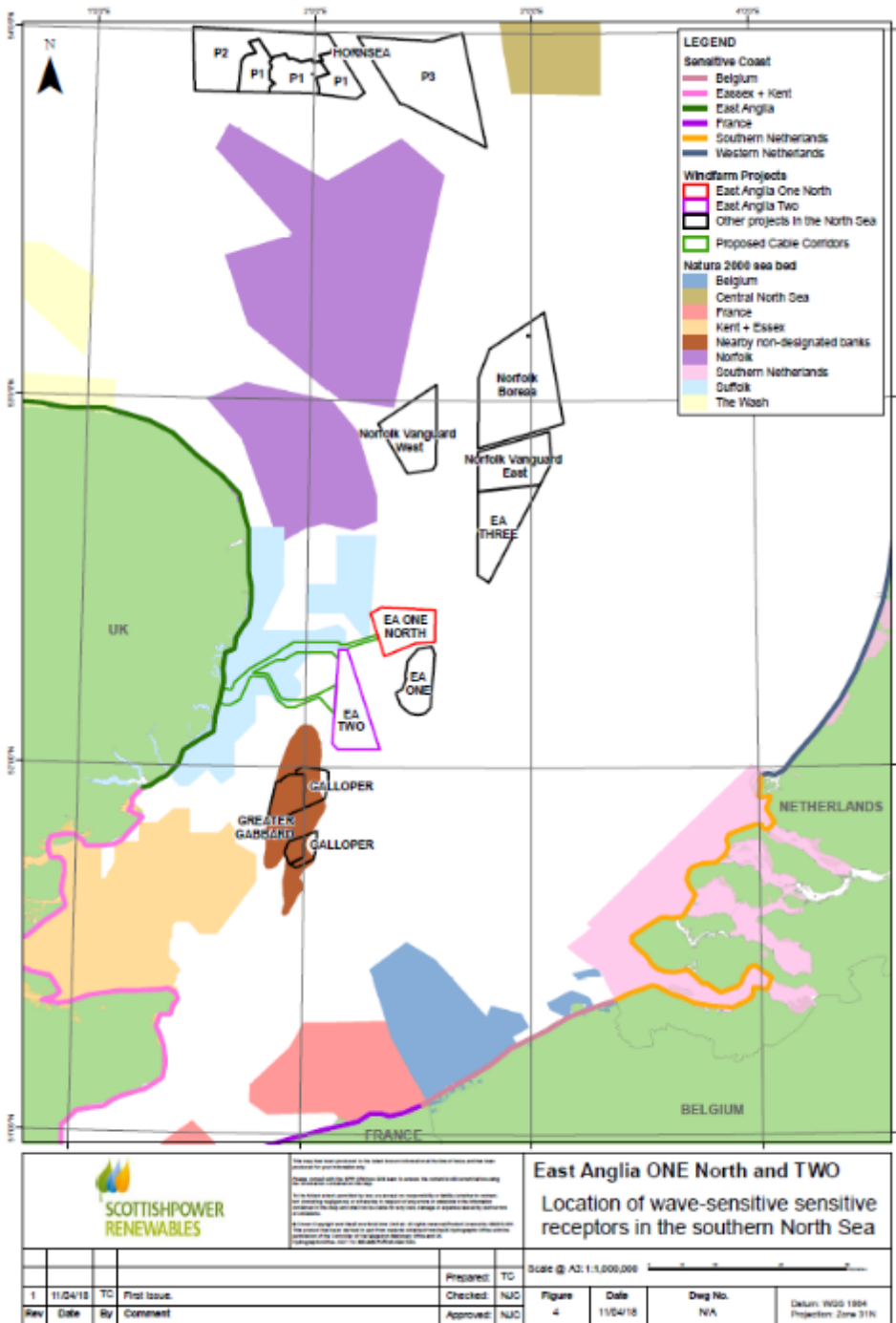

Figure 4: Location of sensitive receptors in the southern North Sea

Wave Regime

153. The greatest potential transboundary effects on the wave regime are associated with the cumulative modelling assessments (rather than the individual project modelling) and with the 1 in 1 year return period event (compared to the 1 in 50 year return period event). Furthermore, the greatest potential cumulative effect on the identified sea bed and shoreline receptors along the mainland European coast was associated with waves from N, due to their alignment with respect to the specific windfarm projects and the Belgian coast in particular.

154. **Figure 5** shows the zone of influence map for this worst case condition for transboundary effects. Note that wave effects would extend marginally southward of the southern model boundary, but dissipate to baseline values within a very short distance of this boundary.

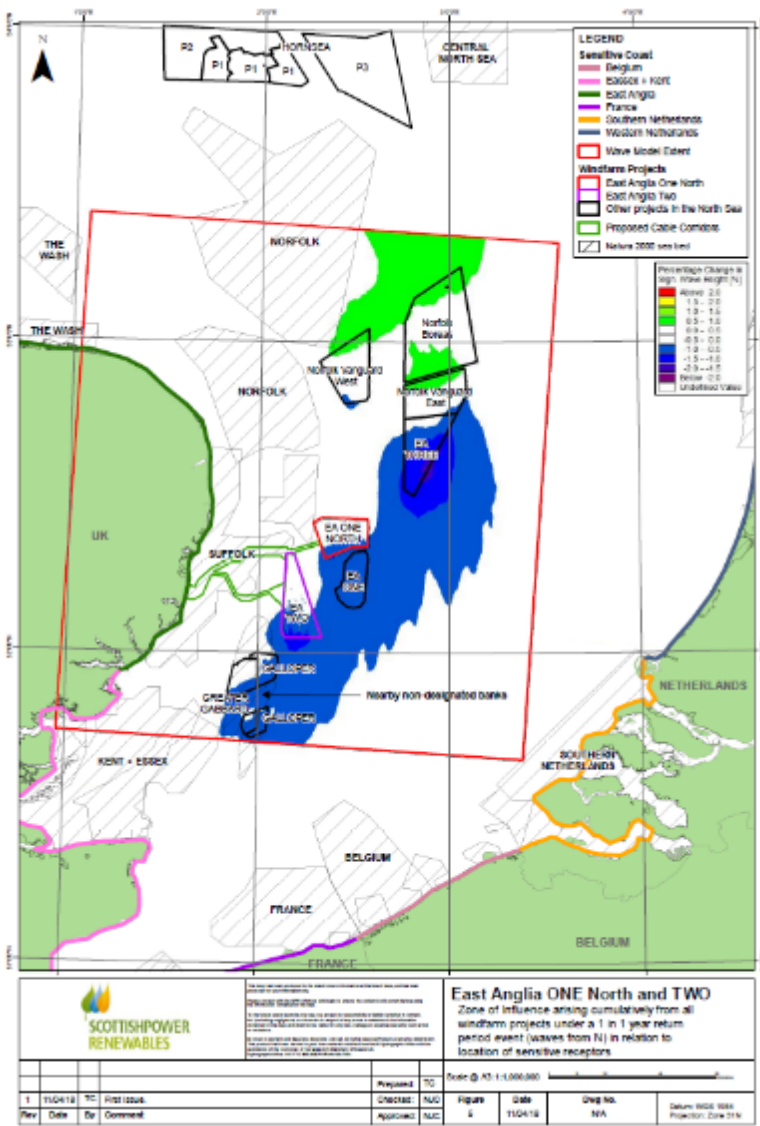

Figure 5: Zone of Influence arising cumulatively from all windfarm projects under a 1 in 1 year return period event (waves from N) in relation to location of sensitive receptors

155. It can be seen that there is no potential for change in baseline wave conditions leading to transboundary effects.

Tidal Regime

156. To assess the potential for transboundary effects to influence the tidal regime, Cefas suggested use of a 'zone of influence' approach that had previously been adopted for other windfarm projects in the former East Anglia Zone, such as East Anglia THREE.
157. This zone of influence is based on an understanding of the tidal ellipses in the area and knowledge that effects arising from wind turbine and platform foundations on the tidal regime are relatively small in magnitude and largely confined locally to near field effects. Generally, it is likely that effects on the tidal regime are dissipated within one tidal ellipse of the obstacle to flow on the sea bed.
158. Based on this principle a zone of influence has been derived from all projects within the former East Anglia Zone as well as Galloper and Greater Gabbard (**Figure 6**).

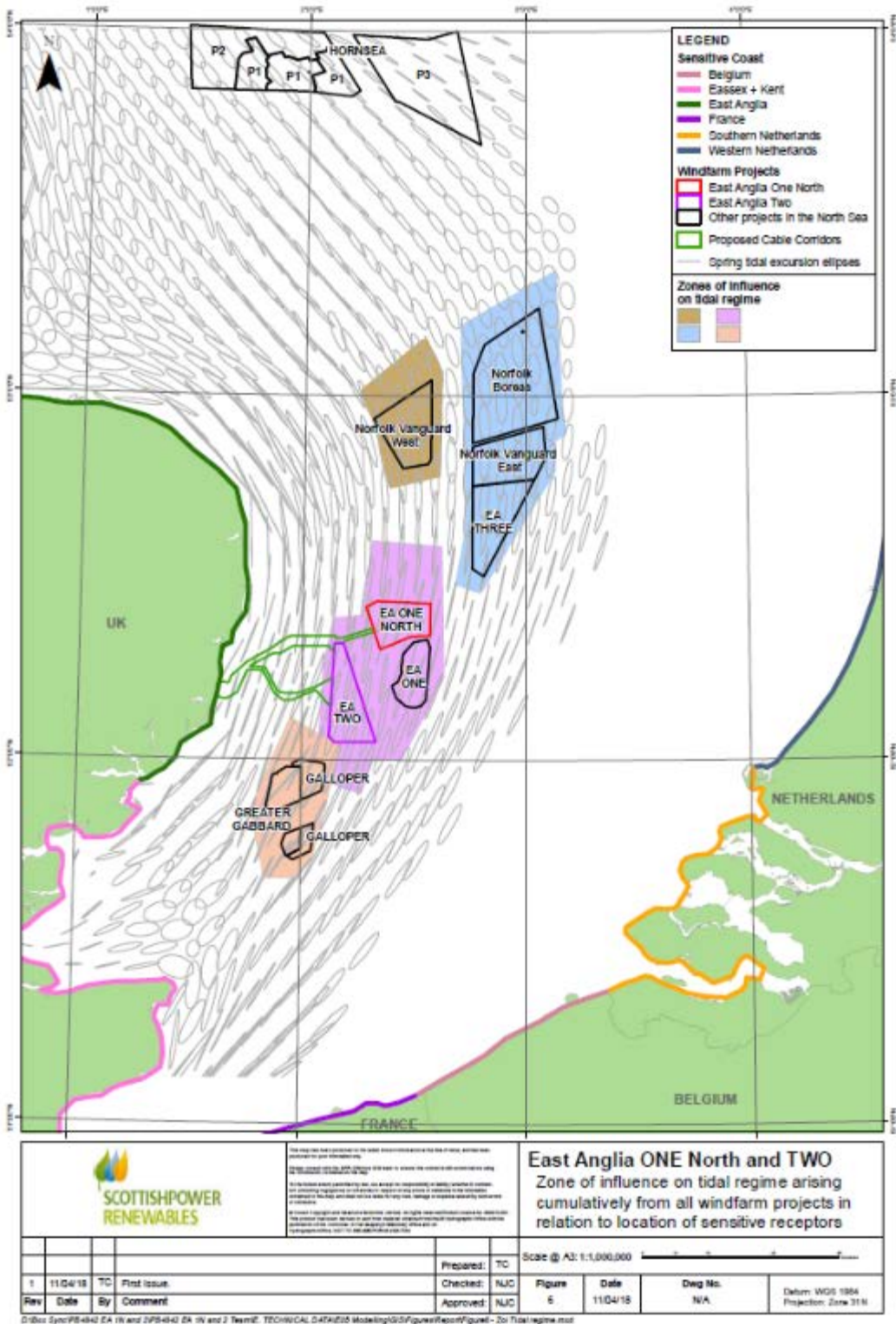

Figure 6: Zone of influence on tidal regime arising cumulatively from all windfarm projects in relation to location of sensitive receptors

159. This shows that the zone of influence from these projects cumulatively can be separated into four distinct locations with no interaction between them, namely:

- Norfolk Vanguard West only;

- Norfolk Boreas, Norfolk Vanguard East and East Anglia THREE cumulatively;
- East Anglia ONE, East Anglia ONE North and East Anglia TWO cumulatively; and
- Galloper and Greater Gabbard cumulatively.

160. Note that whilst there is some overlap between the zone on influence from East Anglia TWO on the flooding tide and the zone on influence from the northern part of Galloper on the ebbing tide within the area of sea bed between these two projects, both of these tidal events cannot occur simultaneously and therefore there will also be a separation of zone of influence between each project grouping.
161. The zone of influence arising from Anglia ONE, East Anglia ONE North and East Anglia TWO cumulatively does marginally impinge upon the edge of part of the 'Suffolk Natura 2000' receptor and the non-designated sandbanks. However, the magnitude of change at these locations will be at its lowest value since it is the most remote area of the zone of influence from the windfarms.
162. Furthermore, the zone of influence shows that there is no potential for transboundary effects arising from changes to the tidal regime.

Sediment Regime

163. Transboundary effects on the sediment regime could arise during the construction phase, in the form of a sediment plume, or during the operation phase if there are significant changes to the wave and/or tidal regimes.
164. Given that there are no transboundary effects arising from changes to the wave or tidal regimes, consideration focuses on the construction phase effects, which will be temporary. Sediment disturbed from the sea bed during installation of cables of foundations may become entrained in a sediment plume and advected by tidal currents under the sediment re-settles on the sea bed. The distance that any plume will travel, and the concentration of the suspended sediment in the water column will depend on both the direction and magnitude of the tidal currents and the size (and hence settling velocity) of the sediments.
165. Any plume that does arise will move in the direction of the tidal currents, which are governed by the tidal ellipses. These are presented in **Figure 7** and it can be seen that there is no potential physical connection, in terms of tidal currents, between the proposed East Anglia TWO and East Anglia ONE North projects and the sensitive shoreline or sea bed receptors in Belgium, France or the Netherlands. Also, these areas are very remote from the proposed developments and it is inconceivable to envisage that sediment entrained within a plume would reside in the water column in sufficient quantities to reach such areas in measureable quantities even if there were a direct physical connection.

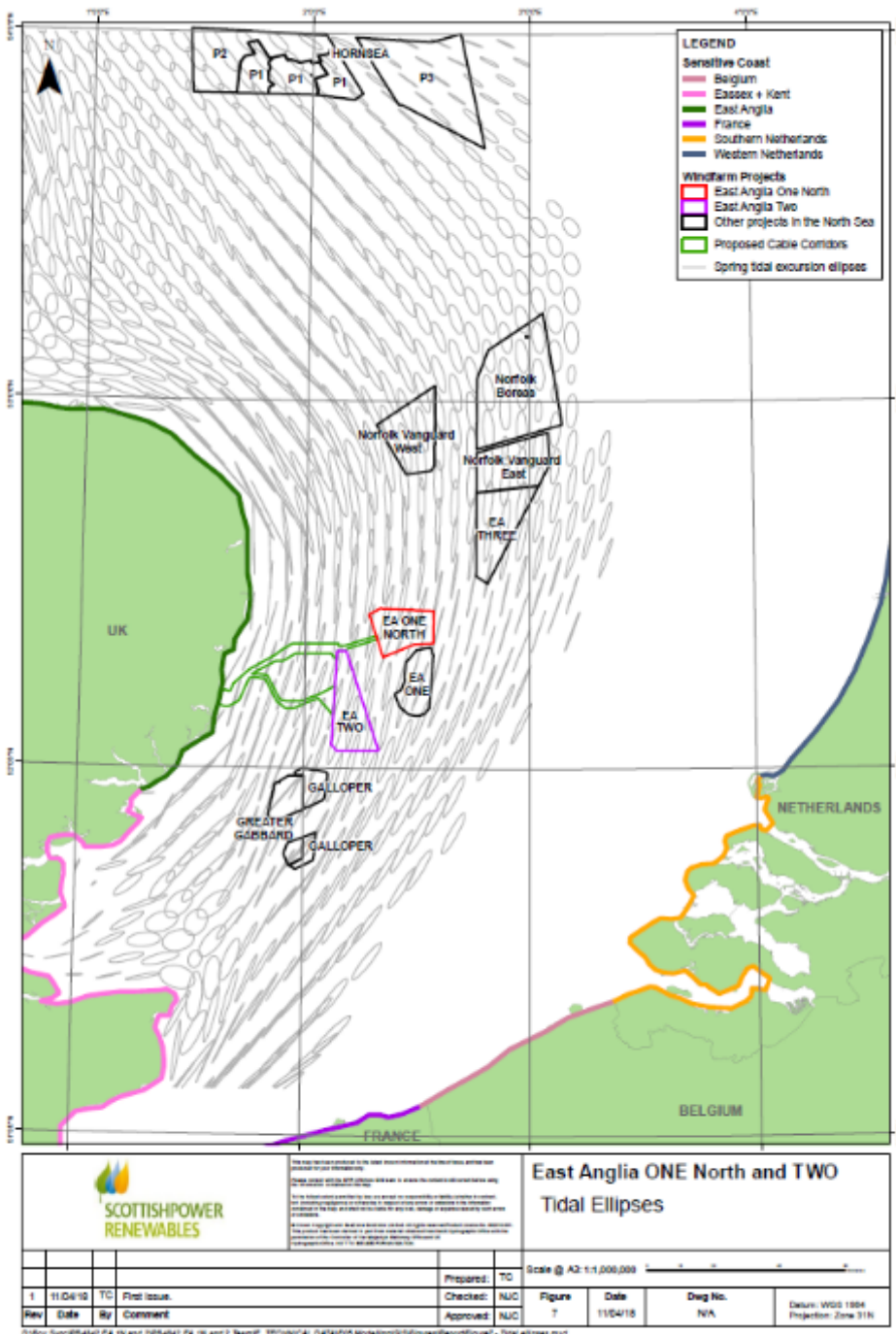

Figure 7: Tidal ellipses

- 166. Due to the above, there is no potential for transboundary effects arising from changes to the sediment regime.
- 167. Given that the zone of influence and tidal cycle in the area will not result in transboundary effects for sediment deposition, or that effects on tidal resource will not result in transboundary effects, it is proposed that there is no pathway for transboundary effects on sea bed sediments and benthic habitat. Therefore, this is presented as justification for scoping out transboundary impacts on benthic habitats.

Conclusion

168. Given that there is no potential for transboundary effects arising from changes to the wave, tidal or sediment regimes, consideration of transboundary effects on physical processes and benthic ecology should be scoped out from further assessments.